

FOODSERVICE CATALOGUE

REFRIGERATION. ICE MAKERS. SPECIALTY.

*The power of precision engineering
and the intelligence of inspired design*



HOSHIZAKI |

GRAM

LEADING NATURALLY





HOSHIZAKI |

GRAM



CHARLOTTE'S W5, LONDON



LONDON AQUATICS CENTRE



MIXOLOGY GROUP, BRIGHTON

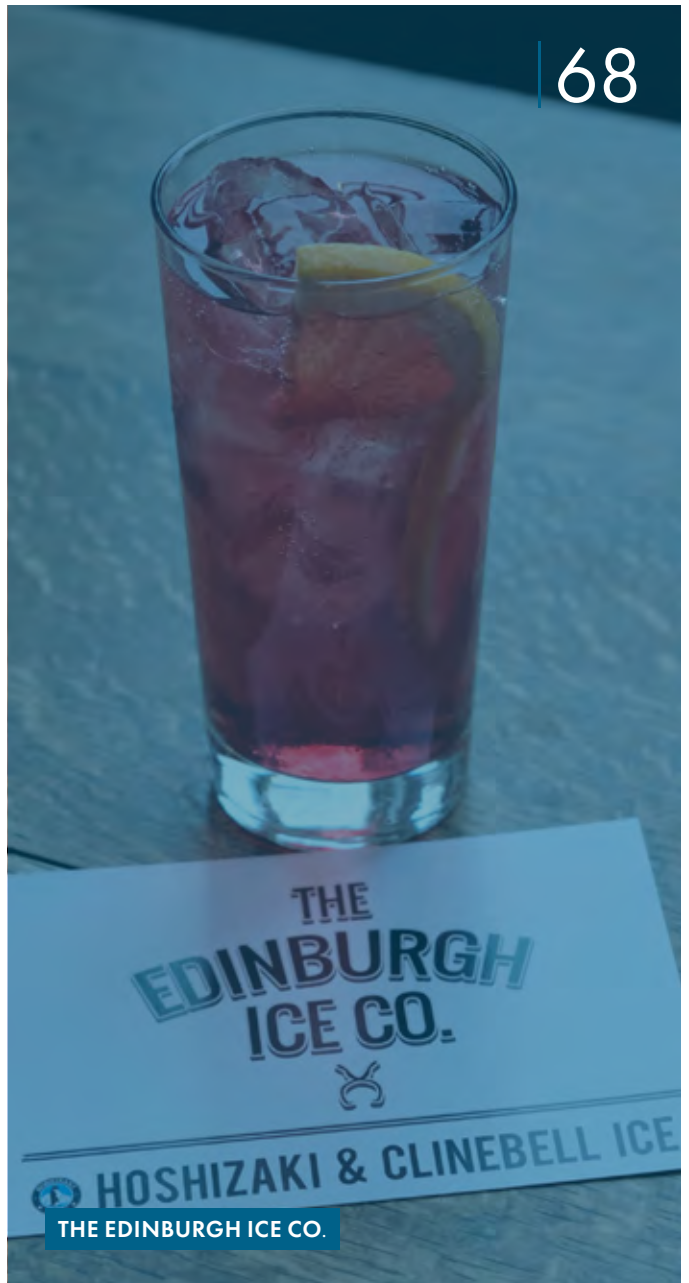

THE EDINBURGH ICE CO.

ABOUT US

- 6 HISTORY
- 8 SUSTAINABILITY
- 10 AFTER SALES

STORAGE CABINETS

- 12 REFRIGERATION
- 14 GRAM SUPERIOR & ECO
- 16 GRAM SUPERIOR
- 18 GRAM ECO
- 20 GRAM STANDARD PLUS
- 22 SNOWFLAKE GII
- 24 GRAM COMPACT
- 28 GRAM ROLL-IN 1500

STORAGE COUNTERS

- 30 **CASE STUDY** CHARLOTTE'S W5
- 32 GRAM GASTRO 07 & 08
- 34 GRAM GASTRO 07
- 36 GRAM GASTRO 08
- 38 SNOWFLAKE GII

COOK & CHILL

- 40 GRAM KPS BLAST CHILLERS/FREEZERS
- 44 SNOWFLAKE BLAST CHILLERS/FREEZERS
- 46 GRAM QUICK CHILLERS/FREEZERS

BAKERIES/PATISSERIES

- 48 REFRIGERATION & PROCESS
- 50 GRAM BAKER
- 52 GRAM STORAGE CABINETS & COUNTERS
- 54 GRAM PROCESS CABINETS

MARINE/OFFSHORE

- 56 REFRIGERATION
- 58 GRAM MARINE
- 60 GRAM MARINE COUNTERS & CABINETS

ICE MAKERS

- 62 ICE
- 64 **CASE STUDY** LONDON AQUATICS CENTRE
- 66 **CASE STUDY** THE MIXOLOGY GROUP
- 68 **CASE STUDY** THE EDINBURGH ICE CO.
- 70 ABOUT CUBE ICE
- 72 CUBE ICE MAKERS
- 74 ABOUT FLAKE & NUGGET ICE
- 76 FLAKE & NUGGET ICE MAKERS
- 78 ABOUT CRESCENT ICE
- 80 CRESCENT ICE MAKERS
- 82 SPECIAL ICE MAKERS

DISPENSERS

- 84 ICE AND/OR WATER DISPENSERS

SPECIALTIES

- 86 SPECIALTY
- 88 SUSHI CASES, RICE COOKERS & THERMAL FOOD HOLDERS

LEADING NATURALLY

With the establishment of offices, service hubs and production facilities spanning almost all European regions, Hoshizaki made an important step towards perfectly serving the European food service industry with suitable products closer to European customers and closer to European requirements.

Placing reliability, durability and energy efficiency at the centre of our design process, generations of Hoshizaki engineers have helped us build an international reputation for high quality, well-designed products.

And by merging with refrigeration specialist Gram Commercial, we have brought together the brilliance of Japanese engineering and the intelligence of Danish design. Our collaboration has created the world's most connected, innovative and responsible manufacturer of cold solutions. Together, we continue to explore the realms of possibility.

Global headquarters:
Aichi, JAPAN
European headquarters:
Amsterdam,
NETHERLANDS



Global sales

1.8 B £



Group of
52 companies
worldwide



Factories
worldwide



HISTORICAL TIMELINE - DOMESTIC OPERATION

1947

Founded
in Japan



1957

Development
of the first juice
vending machine



1970

Development
of the beer
dispenser



1972

Development of
the commercial
refrigerator



1977

Development of
the snow cone
vending machine



1965

Development of
the first automatic
ice maker



1971

Development of
the hamburger
vending machine



1973

Development of
the dish washer



HISTORY

THE HOSHIZAKI CORPORATION COMPANY WAS FOUNDED BY MR. SHIGETOSHI SAKAMOTO WHO DEMONSTRATED REMARKABLE FORESIGHT WHEN HE STARTED OUR COMPANY IN NAGOYA, JAPAN IN 1947.

Mr. Shigetoshi Sakamoto



From an early stage Mr. Sakamoto recognised the need to invest in research and developing own technologies. In 1959, his son Seishi joined the company. Together the pair worked with engineers who shared their vision and the breakthrough came with their invention of the first ice machine in Japan in 1965.



BRINGING TOGETHER JAPANESE AND DANISH ENGINEERING EXPERTISE

What unites both Hoshizaki and Gram is the tireless drive to push borders of engineering - always keeping one eye on the convenience for the ones operating the devices and the other eye on the uncompromised quality of fresh produce.

HISTORICAL TIMELINE - OVERSEAS EXPANSION

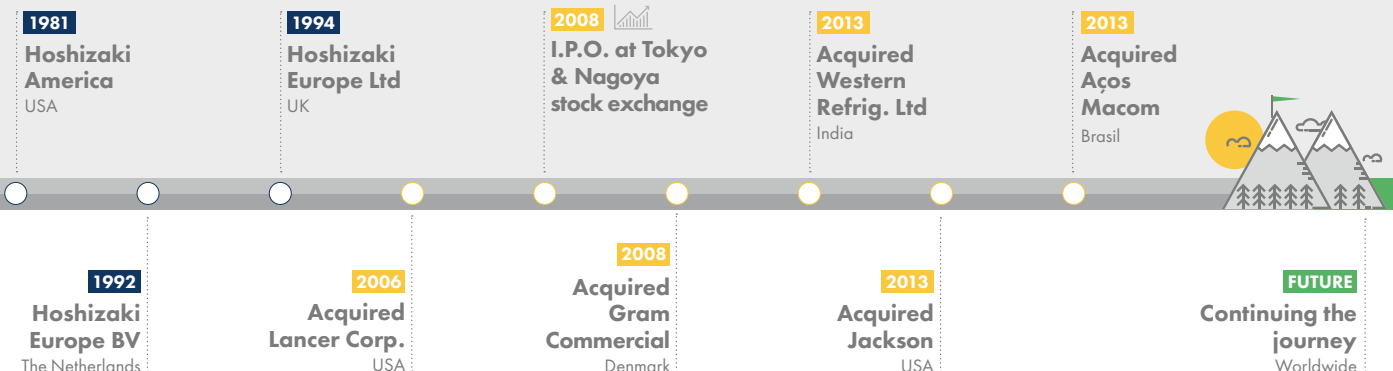

**GREEN. SAFE.
SMART.**

GREEN FOOD SERVICE EQUIPMENT FOR A MORE SUSTAINABLE HOSPITALITY INDUSTRY

Always being first movers on the ground, we quickly understood the impact of sustainable refrigeration and icemakers on our nature, our resources and our budgets.

By adding sustainability to our core values already decades ago, we are now one of the few premium manufacturers with full ranges of energy efficient refrigeration equipment and Ice Makers.

With the ongoing depletion of natural resources, resulting in increased energy and water costs, and emerging energy saving regulations, the food industry of today is confronted with profoundly different challenges than 50, 30 or even only 20 years ago.

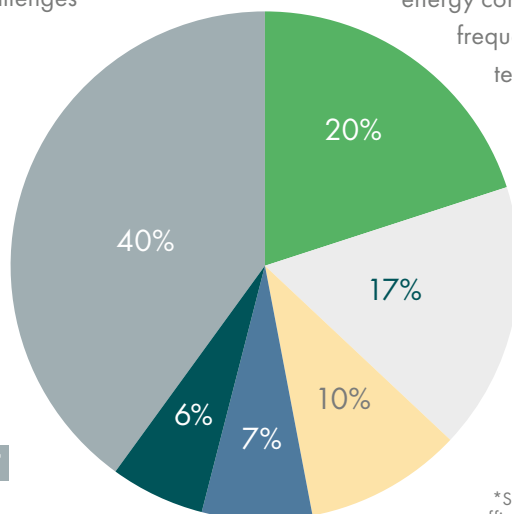

The largest part of the kitchen's electricity consumption is used for cooking, refrigerated storage and dishwashers. In addition, lighting and ventilation draw significant amounts of energy.

Fresh produce requires refrigeration that is usually high in energy consumption, due to uninterrupted running times, frequent door openings and often higher ambient temperatures. On Average, refrigeration applications draw approximately 20% of the overall energy consumption in a commercial kitchen.

Considering these stats and being aware that we have a global reach, we are convinced that our efforts towards a cleaner future can and will have a positive impact, when it comes to overall responsible consumption of energy in commercial kitchens worldwide.

*Source: ProKlima – Der energy-Fonds. Publication: Your Energy – Apply it efficiently (Ihre Energie - Effizient eingesetzt). Information for the Gastronomie

THE BIGGER PICTURE

WE HAVE MADE THE CHOICE TO EMBED OUR **ENERGY EFFICIENT PRODUCTS** IN A HOLISTIC APPROACH TOWARDS CREATING A BETTER AND GREENER FUTURE.



PRODUCTION

We are in the course of implementing renewable energy solutions for our world-wide production sites, warehouses and offices. For example, one of our main production facility (Vojens, Denmark) is heated entirely by a nearby photovoltaic plant.



TRANSPORT

Being present in nearly all geographies gives us the opportunity to continuously optimize our internal and external transport routes, with the effect of improved lead times and reduced CO₂ emissions.



ENERGY EFFICIENCY & DURABILITY

Having introduced Hydrocarbon as refrigerant already in 2002, we are now able to provide the most comprehensive lineup of energy-efficient refrigeration solutions and icemakers in the industry. All our products combine all factors that play into 100% sustainable refrigeration systems and ice makers. A stable and durable design combined with first-class materials are the biggest contributors for a product that is built to last.



RECYCLING

Most components of our machines (95%) are made of recyclable materials. Thus, the disposal process feeds back into a new production cycle.



OUR COMMITMENT

The most impactful aspect of our development towards a more sustainable future remains our commitment to **gradually phase out HFC refrigerants in all our products** and replace them with HC Gases, such as R290.

THINK GLOBAL, REACH LOCAL

WE ARE WHERE YOU NEED US TO BE

Our local teams and their deep understanding of the highly demanding requirements on the ground have always been key to staying ahead of country-specific regulative requirements, certifications and preferences - always ready to supply each market and each segment of the food service industry with a suitable and sustainable premium product.

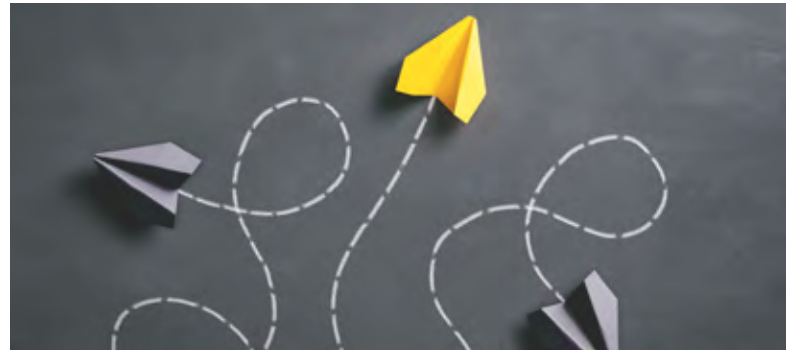

PROPER CARE FOR A BOOSTED DURABILITY AND PERFORMANCE - AND IT IS SO SIMPLE!

Hoshizaki Ice Makers and Refrigeration Appliances are considered to be one of the most durable, reliable and energy efficient devices available for Foodservice Industry, always keeping the best possible commercial refrigeration equipment, in the industry it is considered as a true investment in improving

quality, hygiene, staff safety and your energy consumption. We encourage our customers to make use of the assistance we provide when it comes to correct installation, maintenance and repair to expand the life expectancy of your device.

**RESPONSIVE AND
REGIONAL SUPPORT
INFRASTRUCTURE**



**MULTI-LINGUAL
SUPPORT AND TECH
SERVICE TEAMS**



**TECHNICAL TRAININGS
FOR REPAIR,
INSTALLATION AND
MAINTENANCE**



**DEEP UNDERSTANDING
OF LOCAL
REQUIREMENTS,
GUIDELINES AND LAWS**



ALL-ROUND SUPPORT

WITH EVERY REQUEST, CONSULTATION OR PURCHASE, HOSHIZAKI INTENDS TO BUILD A LONG-TERM PARTNERSHIP : THAT INCLUDES A SERIES OF STEPS TO PROVIDE ALL-ROUND SUPPORT FOR ALL TYPES OF CUSTOMERS FROM A TO Z, NO MATTER IF YOU ARE A DIRECT OR INDIRECT CUSTOMER OF HOSHIZAKI.



I JUST PURCHASED A PRODUCT. WHO DO I TALK TO NOW?

From Day 1, every customer is assigned to a dedicated contact person, either with us or with one of our partners. We believe in direct communication, as well as quick and unbureaucratic contact with all our users and partners.



HOW CAN I EXPAND MY HOSHIZAKI'S LIFE EXPECTANCY?

Following your purchase, we support you in maintaining and cleaning your machine properly. It is about sharing the knowledge that helps you to maintain and clean your machine at any given time. The better you care for your machine, the longer it lasts.



MY MACHINE HAS REACHED ITS LIMITS, WHAT DO I DO NOW?

Even the most durable machine comes to its limits one day. When this day comes, you don't have to bother with the disposal, recycling & replacement process. Hoshizaki will take care of everything, once your machine is ready to be disposed.

COMPREHENSIVE AND UP-TO-DATE TECHNICAL SUPPORT MATERIAL **FOR FREE**



WORLDWIDE NETWORK OF SUPPORT STATIONS, SERVICE PARTNERS AND REFRIGERATION TECHNICIANS



BUSINESS **FRIENDLY** WARRANTY TERMS AND CLAIM PROCESSING



I BELIEVE THAT GREAT CHEFS HAVE A RESPONSIBILITY TO DO MORE THAN SERVE GOOD FOOD. CHEFS SHOULD SERVE THE WORLD AND USE THEIR PLATFORMS TO CREATE AWARENESS ABOUT SUSTAINABILITY AND SOCIAL RESPONSIBILITY.

Rasmus Munk

Co-owner & Head Chef
Restaurant Alchemist, Copenhagen

PREMIUM REFRIGERATION FOR INDIVIDUAL NEEDS

As a supplier to the foodservice industry for many decades we have developed long-lasting relationships. It is the long-term development of our clients that matters. And the new generations of hard-working and ambitious chefs.

Foodsafe, energy efficient and sustainable refrigeration that is easy to work with is what our customers ask for. This is what drives us.

“Your success is our motivation”

A correct and uniform temperature throughout your refrigerator is essential. This is a prerequisite for handling food items in line with the HACCP guidelines.

For this, an efficient air distribution system of your refrigerator is essential. Further it also reduces food waste and extends shelf life.



SAFE, FUNCTIONAL AND HIGHLY EFFICIENT



Category: vertical chilled storage cabinets



QUICK GUIDE

- ✓ For commercial kitchens/back of house professional
- ✓ Kitchens and Front of House within Horeca business
- ✓ Suitable for operations in ambient temperatures of up to +40°C
- ✓ Heavy-duty cabinets: Climate class 5
- ✓ High performance: stable temperatures despite frequented door openings
- ✓ Meets Gastronorm and shelf size standards

LEGS, CASTORS OR PLINTH MOUNTING



L1: 100 - 130 mm - **L2** (standard): 135 - 200 mm

C1: castors 110 mm - **C2:** castors 125 mm

Prepared for plinth mounting at no extra charge.

TEMPERATURE RANGES

K	M	F
+2/+12°C	-5/+12°C	-25/-5°C

Refrigerator

Fresh meat cabinet

Freezer

GRAM SUPERIOR & ECO

KEY FEATURES

MAXIMUM HYGIENE AND ERGONOMIC STANDARDS

1. Controls concealed behind the top panel, protected against splashing water
2. Low noise and heat emission: low noise level peaking at approx. 45 dB(A)
3. Full length aluminium profiles impart additional strength and durability
4. Wall rails that fit into dishwashers
5. Removable door gasket for easy cleaning
6. Self-closing door with full-height handle providing easy access for cleaning
7. Pan-shaped inside base to catch fluids
8. Patented pedal door opener. Same opener can be placed left or right side



Top view of the profile
 Inside door handle:
 2 mm aluminium profile

USAGE AREAS



*Food storage only, not for bio-medical purposes

FOOD SAFE



The efficient air circulation system helps maintaining perfect storage temperatures. Designed to recover the inside temperature rapidly after each door opening. Temperatures for optimal food safety are maintained for climate class 5.

LOW-RUNNING COSTS

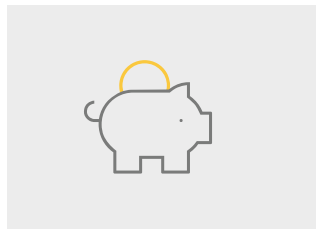

Life time costs of equipment is key to any professional kitchen. The GRAM SUPERIOR PLUS 72 refrigerator has the lowest running costs in its class throughout Europe (topten.eu).

LOW NOISE

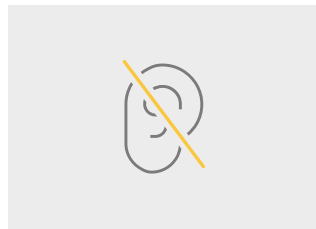

The SUPERIOR range contributes to a healthier work environment with low noise levels at approx. 45 dB(A), when the compressor is running.

MAXIMUM HYGIENE STANDARDS

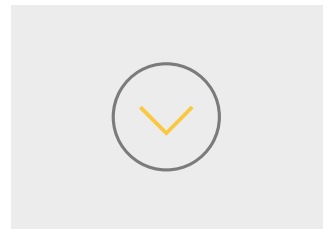

Thanks to the rounded corners and smooth surfaces, frequented cleaning routines become a quick and simple task. Specific features are highlighted above.

PRODUCT LINE-UP

FOR YOUR HIGHEST STANDARDS



ABOUT THE SUPERIOR

GRAM SUPERIOR is a series of high performance cabinets, meeting the sophisticated expectations of our customers, who operate in both casual and fine dining kitchens. Stable and uniform temperatures throughout the cabinet is provided, whilst keeping energy consumption on a revolutionary low in the heat of a commercial kitchen.

SUPERIOR cabinets are characterised by a transparent top panel of impact resistant material.

SUPERIOR K 72 G - winner of 6 sustainability and product excellence awards, including ProCold 'Most Energy Efficient Product in Europe' Award and the Green Good Design award.

MATERIALS & COMBINATIONS

EXTERIOR

Stainless steel **C**

Vario silver **R**



White finish **L**

INTERIOR

Stainless steel **C**

Stainless steel **C***

Aluminium **A**

Stainless steel **C***

Aluminium **A**

*Combination is available for refrigerators with temperature range -5/+12°C



SUPERIOR PLUS 72

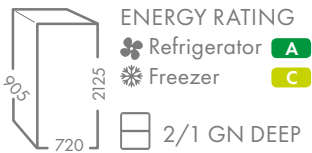

SUPERIOR TWIN 84

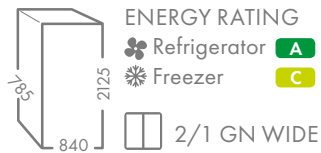

SUPERIOR EURO 62

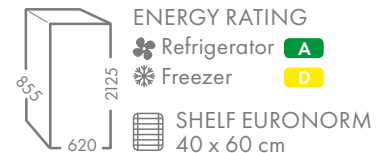

**LET'S COMPARE!
UPGRADE NOW – AND START
CUT RUNNING COSTS!**

Save up to **79%**

	INEFFICIENT MODEL*	SUPERIOR PLUS K 72 G
⚡ Energy consumption	1348 kWh/year	285 kWh/year
📏 Ecodesign Energy rating	G	A
<i>Total costs after 8 years*</i>	£ 1,553.-	£ 328.-

With this A-rated model you save 79% on energy costs compared with a G-rated model.

*£ 0.144/kWh. Data according to Topten.eu

PRODUCT LINE-UP

MEETING THE NEEDS OF DIVERSE KITCHENS



ABOUT THE ECO RANGE

The ECO series gained enormous popularity among our customers across all segments of the hospitality and the food service industry. One of the reasons is the wide span of models for different usage areas and purposes. The series can accommodate the most diverse of needs, especially when it comes to capacity and functionalities. At the same time, it does not compromise on energy efficiency and low running costs.

Depending on your specific needs, you can choose your individual setup:

- Single, double or half doors
- Insulated door or glass door
- One or two temperature ranges in one cabinet
- Top or bottom mounted compressor
- Optionally equipped for bakeries or marine

EXTENDED OPTIONS

-  ECO PLUS 70, half door cabinets.
Convenient for i.e. fastfood restaurants.
-  ECO TWIN 82, combi-cabinets.
Combining 2 temperature ranges in one cabinet.
-  GLASS DOOR CABINETS, across all series
Freezers with glass door in the MIDI series.



MIDI alternatively with illuminated advertising display panel

MATERIALS & COMBINATIONS

EXTERIOR INSULATED & GLASS DOOR

Stainless steel **C**

Vario silver **R**

White finish **L**

INTERIOR INSULATED DOOR

Stainless steel **C**

Stainless steel **C*** (not for MIDI)
Aluminium **A**

Stainless steel **C*** (not for MIDI)
Aluminium **A**

INTERIOR GLASS DOOR

Stainless steel **C**

Aluminium **A** (not for glass door-MIDI)

Aluminium **A** (not for glass door-MIDI)
White finish **L** (only for glass door-MIDI)

*Combination is available for refrigerators with temperature range -5/+12°C



Top-mount
compressor

ECO PLUS 70

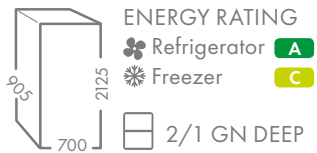

Top-mount
compressor

ECO PLUS 140

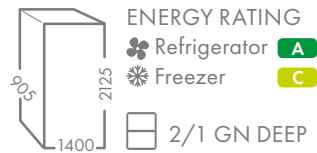

Top-mount
compressor

ECO TWIN 82

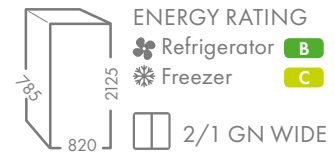

Top-mount
compressor

ECO EURO 60

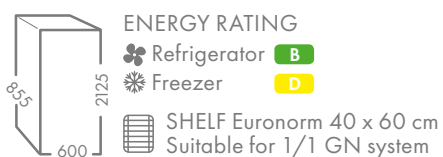

Bottom-mount
compressor

ECO MIDI 60

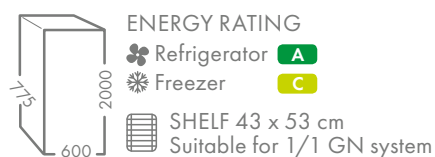

Bottom-mount
compressor

ECO MIDI 82

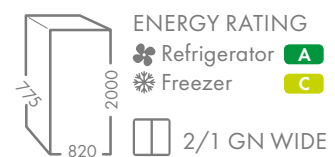

THE RIGHT FRIDGE FOR THE RIGHT JOB

ACKNOWLEDGED VIRTUES AND EXTENDED HACCP FUNCTIONS

Food safety is paramount to our customers. GRAM STANDARD PLUS acknowledges this and offers two different stainless steel options to match your requirements. Another dimension of this range is the extended HACCP functionalities that ease your own control procedures. Find the perfect fridge for your individual requirements: The series comprises six models – three temperature ranges combined with the choice of two different brushed stainless steel finishes.

HYGIENIC AND ERGONOMIC FEATURES

1. | Easy monitoring and easy own-control*
2. | Low noise, only 44,4 and 44,5 dB(A) for fridge and freezer. Short compressor running times ensures low heat emission
3. | Temperature stability with air circulation system
4. | Removable door gasket for easy cleaning
5. | Self-closing door with integrated, full-height Easy grip and easy access for convenient cleaning
6. | Choice of 2 brushed stainless steel finishes: SSG and FFG models
7. | SSG models with 3 stainless shelves. FFG with 3 grey coated shelves
8. | Features for hygiene, such as pan-shaped inside base to catch fluids
9. | Pedal door opener for hands free operation (optional extra)



* Extended HACCP functionalities for easy monitoring and own control. HACCP data can be easily accessed from the controller and downloaded via a RS485 interface (optional extra) for review on your PC.



GRAM STANDARD PLUS



Interior **SS**
Exterior **SS**



Interior **FF**
Exterior **FF**

USAGE AREAS



Catering Healthcare* Education



Hospitality Leisure Bakery

*Food storage only, not for bio-medical purposes

STANDARD PLUS 69 SSG

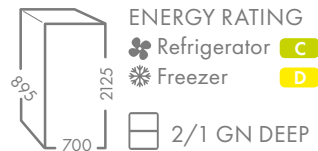

STANDARD PLUS 69 FFG



QUICK GUIDE

- ✓ Ideal for commercial kitchens (Front of House/ Back of House)
- ✓ Suitable for use in ambient temperatures of up to +40°C (tropical)
- ✓ Heavy Duty cabinets: Climate class 5
- ✓ High performance, ensuring temperature stability despite frequent door openings
- ✓ Meets 2/1 deep Gastronorm standard

TEMPERATURE RANGES

K +2/+12°C	M -5/+12°C	F -22/-10°C
Refrigerator	Fresh meat cabinet	Freezer

MATERIALS & COMBINATIONS

EXTERIOR

Stainless steel **SS**
AISI 304

Stainless steel **FF**
AISI 430

INTERIOR

Stainless steel **SS**
AISI 304

Stainless steel **FF**
AISI 430

Stainless steel is nickel-free

PRODUCT LINE-UP

RELIABLE. DURABLE.
AFFORDABLE.

QUALITY COOLING YOU CAN RELY ON

The Snowflake GII refrigerated and freezer cabinets are brought to you by Japanese and Danish engineering excellence, dedicated to simplifying day-to-day work routines of kitchen staff all around the world. The technology behind the performance of Snowflake GII is the tropicalised cooling system enduring up to +40°C. Additionally, the cooling agent of the new generation of Snowflake is the eco-friendly refrigerant R290, a natural gas (HC) that enhances the performance and cuts down energy consumption significantly. Both interior and exterior are built of sturdy and easy-to-clean stainless steel AISI 304, which is among the best choices when it comes to materials for hygienic and food safe cooking environments.

FOOD SAFE, HYGIENIC AND ERGONOMIC

1. | Ergonomic full-height handle
2. | Cabinet height of < 2m for low-ceiling buildings and kitchens
3. | Removable and double insulated magnetic gaskets for easy clearing and minimal heat dispersion
4. | High grade stainless steel AISI 304
5. | Reversible door for flexibility
6. | Easy-to-clean interior and shelves with anti-tilting function to prevent from tilting when pulled out
7. | Inside base with rounded corners for easy cleaning

LEGS, CASTORS OR PLINTH MOUNTING



L: Legs 130 mm

C: Castors 130 mm

Plinth mounting at site by removing legs or castors.





USAGE AREAS



Catering Healthcare* Education



Hospitality Leisure

*Food storage only, not for bio-medical purposes

SUR-65BG/SUF-65BG

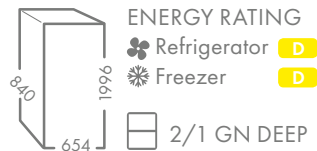

SUR-135BG/SUF-135BG

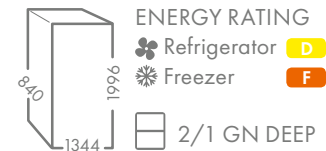

QUICK GUIDE

- ✓ Ideal for commercial kitchens (Front of House/ Back of House)
- ✓ Suitable for use in ambient temperatures of up to +40°C (tropical)
- ✓ Heavy Duty cabinets: Climate class 5
- ✓ High performance, ensuring temperature stability despite frequent door openings
- ✓ Meets 2/1 deep Gastronorm standard

TEMPERATURE RANGES

K -2/+8°C	F -20/-10°C
Refrigerator	Freezer

MATERIALS & COMBINATIONS

EXTERIOR

Stainless steel **C**
AISI 304

INTERIOR

Stainless steel **C**
AISI 304

Stainless steel is nickel-free

PROFESSIONAL REFRIGERATION - THE COMPACT WAY

A LOT MORE THAN JUST A BOTTLE COOLER

The GRAM COMPACT series offers a rare combination: They are food safe cabinets with a compact size and with excellent energy ratings for its class. With a footprint of only 59,5 x 64 cm these small space storage cabinets are easy to fit in especially when space is of a premium.

This makes the GRAM COMPACT series such a popular choice of small-kitchen-operators who, in most cases, do not require heavy-duty Gastronorm refrigeration equipment.

- ✓ Ideal for commercial kitchens concerned with food preparation (rather than food production)
- ✓ These small footprint cabinets are a perfect pick for self-service areas and satellite kitchens
- ✓ Suitable for all light-duty kitchens where complete stainless steel is not required
- ✓ Suitable for use in ambient temperatures of up to +30°C. Climate Class 4: normal-duty cabinets



COMPACT 410

LEGS, CASTORS OR PLINTH MOUNTING



L1: 100 - 130 mm - **L2** (standard): 135 - 200 mm
C2: castors 125 mm

TEMPERATURE RANGES

K	M	F	F
+2/+12°C	-5/+12°C	-22/-5°C	-25/-5°C
Refrigerator	Fresh meat cabinet COMPACT 610	Freezer COMPACT 210/310/410	Freezer COMPACT 610



GRAM COMPACT

KEY FEATURES

FOOD SAFE, HYGIENIC, ERGONOMIC AND GOOD WORK ENVIRONMENT

1. | Low noise ratings
2. | Air circulation system ensure temperature stability
3. | Removable door gasket for easy cleaning
4. | Full-height integrated handle. Easy grip and easy access for cleaning
5. | Nickle-free stainless steel (stainless models) – no risk of allergic reactions
6. | Anti-spillage and waste control: shelves are equipped with tilt prevention
7. | Automatic defrost
8. | ABS inner lining in one piece: no gaps, no accumulation of contamination
9. | Pedal door opener for handsfree operation (optional accessory, not included for COMPACT 210)



USAGE AREAS



Catering Healthcare* Education Hospitality Leisure Marine

*Food storage only, not for bio-medical purposes

 CABINETS WITH GLASS DOOR
The door is equipped with LED lighting to provide perfectly illuminated storage goods.



FOOD SAFE



Thanks to the Gram air distribution system temperatures are correct and uniform throughout the entire cold room, ensuring perfectly food safe temperatures at all times - not just for bottle cooling.

LOW-RUNNING COSTS

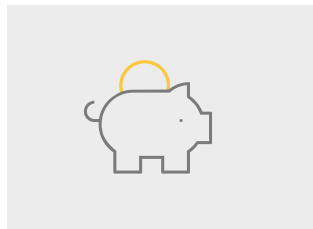

With energy labels ranking from A to C (HC models), the COMPACT 210, 310 and 410 offer the most energy efficient, compact models in the marketplace.

LOW NOISE

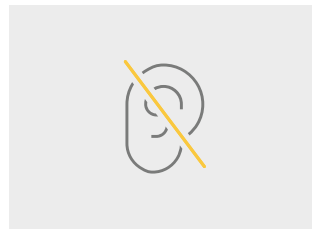

Contributes to a healthier work environment with low noise levels from 34,3 to 39,6 dB(A), when compressor is running. Low heat emission due to short compressor running times.

HIGH STANDARD IN HYGIENE

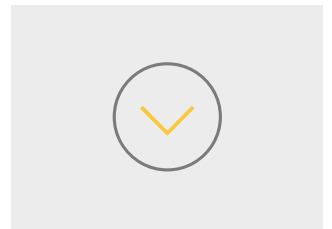

Designed for easy cleaning with smooth surfaces throughout. Specific features are highlighted above.

PRODUCT LINE-UP

VERSATILE, FLEXIBLE AND ROBUST

HIGHLY VERSATILE AND SPACE SAVING

COMPACT offers a range of highly versatile products: No matter if it's stand-alone, side-by-side, as column combinations, or as wall suspended product - all requirements can be covered. The undercounter COMPACT 210 fits under worktops. However, as stand-alone device, it provides extra work space with its 'table top'.

CONFIGURATIONS



COLUMN COMBINATION: Combine the COMPACT 210 fridge and freezer in one column. This construction can be mounted on site or ordered pre-mounted as an entire unit (Stacking kit required).



WALL-MOUNTED: Can be wall-mounted for easy cleaning using a wall suspension kit.



SIDE-BY-SIDE COMBINATION: Refrigerators and freezers of equal height are often placed side-by-side.



COMBINE WITH MICRO WAVE OVEN: The 'table top' of COMPACT 310 is an ideal location for a micro wave oven, offering just the right ergonomic working height.

MATERIALS & COMBINATIONS

EXTERIOR INSULATED & GLASS DOOR

Stainless steel



White finish



INTERIOR INSULATED DOOR

ABS grey



(COMPACT 210, 310, 410)

ABS white



(COMPACT 210, 310, 410)

ABS grey



(COMPACT 610)

ABS grey



(COMPACT 610)

INTERIOR GLASS DOOR

ABS white



(COMPACT 210, 310, 410)

ABS white



(COMPACT 210, 310, 410)

ABS grey



(COMPACT 610)

ABS grey



(COMPACT 610)

Stainless steel is nickel-free



COMPACT 210

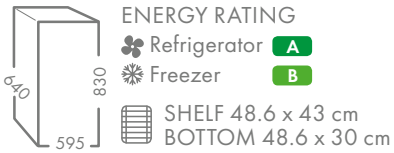

COMPACT 310

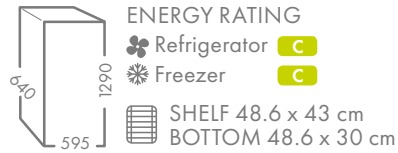

COMPACT 410

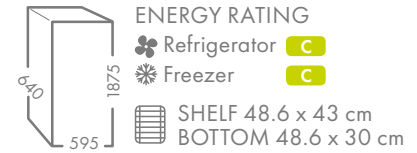

COMPACT 610

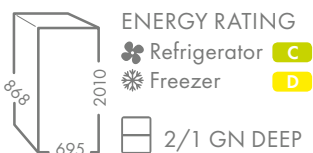

ALL GRAM COMPACT REFRIGERATORS ARE ALSO AVAILABLE WITH GLASS DOOR

📱 ENERGY RATINGS
 Not yet regulated

KEEP UP THE COLD CHAIN

LIGHTEN YOUR WORKLOAD AND KEEP THE COLD CHAIN UNBROKEN

Roll-in cabinets are designed for temporary refrigerated storage within a production line, positioned for example between blast chillers and refrigerated coldrooms. By utilising roll-in cabinets, the refrigeration process is unbroken, minimizing any manual workload for handling and re-loading. Typically, roll-in units are used for commercial kitchens with focus on production, preparation and cook-chill operations.

EFFECTIVE TEMPERATURE CONTROL: HYGIENIC, SAFE AND STURDY

1. Safety first – controller with built-in alarm, door surveillance and emergency programs
2. Two halogen lamps provide illumination when the door is opened (models with insulated door)
3. Temperature stability with air circulation system
4. Removable door gasket for easy cleaning
5. Nickel-free stainless steel: no risk of allergic reactions.
6. Reversible door with cold-retaining strip. Sturdy handle with a 'positive' closing system
7.  Cabinets with glass doors are equipped with an integral light
8. Impact cushions protect the stainless surfaces from bumps and knocks
9. A compact stainless steel floor with drive-in ramp is optional for K & M models. Roll-in freezer comes with heated floor as standard





K & M 1500 REFRIGERATOR

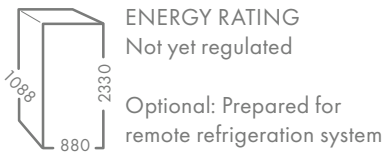

ENERGY RATING
Not yet regulated

Optional: Prepared for remote refrigeration system

Dimensions internal: W 720 x D 895 x H 1900



KG 1500 REFRIGERATOR WITH GLASS DOOR

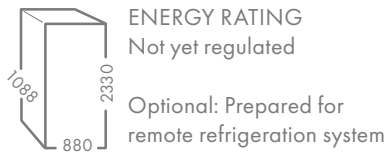

ENERGY RATING
Not yet regulated

Optional: Prepared for remote refrigeration system

Dimensions internal: W 720 x D 895 x H 1900



F 1500 FREEZER

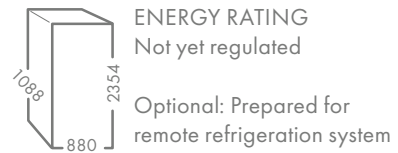

ENERGY RATING
Not yet regulated

Optional: Prepared for remote refrigeration system

Dimensions internal: W 720 x D 895 x H 1900

USAGE AREAS



Catering Hospitality Bakery

- ✓ With an internal clear height of 1900 mm the cabinets are ideal for most trolleys currently used in commercial kitchens
- ✓ Heavy-duty cabinets: Climate class 5. Suitable for use in ambient temperatures of up to +40°C (tropical)
- ✓ High performance: Temperature stability despite frequented door openings

TEMPERATURE RANGES

K +2/+12°C	M -5/+12°C	F -25/-5°C
Refrigerator	Fresh meat cabinet	Freezer

MATERIALS & COMBINATIONS

EXTERIOR

Stainless steel **C**

INTERIOR

Stainless steel **C**

Stainless steel is nickel-free



"We can't afford for a fridge to break down, even short term."



WE NEED EQUIPMENT THAT CAN DELIVER

The kitchen has four undercounter units - one for meat and fish, one for garnish, one for larder and pastry, and another one for breakfast servicing.

The undercounter units found in the kitchen at Charlotte's W5 feature refrigerated drawer storage space in a range of sizes. Each drawer is specifically designed for its Gastronorm compatibility and the units are fitted with castors for simple positioning and to simplify cleaning routines.

"I find the size and format of the GRAM GASTRO range to be extremely versatile. We can fit up to nine of the GN 1/4 containers in each drawer – something that is particularly useful in our garnish fridge, which we use for a variety of different ingredient." Lee states.





CHARLOTTE'S W5

LONDON, ENGLAND

Award-winning

Bar and restaurant in West London

Establishment address

Longfield Avenue, Ealing, West London

Head Chef

Lee Cadden

Launch year

2016, part of renowned 'Charlotte's Group'

Gram equipment

Four GRAM GASTRO undercounter units

Charlotte's W5 is the newest addition to the strong portfolio of three restaurants in West London. They all are part of the renowned 'Charlotte's Group', founded in 1984 by CEO Alex Wrethman. Stunningly set in a converted warehouse, right in the trendy borough of Ealing, the bistro attracts a mix of loyal local guests and visitors from far away, obviously triggered by the overwhelmingly positive echo in the past years.



"In order to maintain freshness and produce the menu our guests expect, we need equipment that can deliver, and though it might not be an exciting piece of kit, having reliable refrigeration is vital."



Charlotte's W5 is a British Brasserie with a menu built around the quality, provenance and sustainability of ingredients. The sourcing of ingredients is vital to creating the ever-changing dishes on the menu.

THE CHEF'S PRIME WORKSTATION



GASTRO 07 SALADETTE

A HIGHLY MODULAR WORKHORSE

A refrigerated counter is the chef's prime workstation. Therefore it often occupies a central position in the kitchen. Besides its storage function the counter has a central role from preparation through to arranging and serving the food.

The GRAM GASTRO 07 and 08 ranges offer highly modular refrigerated counters in a variety of configurations. They are popular with our customers because they can deliver, day in and out, with excess refrigeration capacity.

TEMPERATURE RANGES

K +2/+12°C	K 0/+10°C	M -5/+12°C	F -25/-5°C
----------------------	---------------------	----------------------	----------------------

Refrigerator

Snack counter

Fresh meat

Freezer

QUICK GUIDE

- ✓ Application areas: from hot commercial kitchens to the elementary lunch line. For back of house or as workstation at front of house, cold buffets or as a serving station, use in production lines from raw materials to finished items and food preparation and storage at the point of preparation
- ✓ Prep-counters for catering and food processing, restaurants, bars or cafés. Snack counters are refrigerated low counters combined with modular cooking appliances. Ideal also as pass-through for double working stations
- ✓ Heavy-duty cabinets: Climate class 5 refrigerators for hot professional kitchens. Freezers: Climate class 4
- ✓ High performance counters: stable temperatures despite frequented door openings
- ✓ Compliant with Gastronorm standards

KEY FEATURES

GOOD HYGIENE, ERGONOMICS AND WORK ENVIRONMENT

1. | 'Drip nose' edges on worktops prevent ingress of water
2. | Worktops with splash backs to protect your counter from spillage
3. | Air circulation system for temperature stability
4. | Removable drawer and door gaskets for easy cleaning
5. | Pan-shaped inside base with rounded corners catches fluids
6. | Ergonomic and height-adjustable working station with electrical elevation*
7. | Anti-tilt shelves and drawers with pull-out stop
8. | Extra-long telescopic rails on drawers – GN trays can be lifted in and out without tilting
9. | Maximum Hygiene: rounded corners, minimal screws and fixings for easy wiping
10. | Allergy-proof: counters are made from nickel-free stainless steel



*ULTIMATE ERGONOMICS
Entirely flexible working height between 850 – 1050 mm with electric elevation (optional).



USAGE AREAS



Catering Healthcare* Education Hospitality Leisure Marine Bakery

*Food storage only, not for bio-medical purposes

FOOD SAFE



Thanks to the Gram air distribution system, temperatures inside the counters maintain a uniform and correct temperature at all times. This includes rapid temperature recovery after every door opening.

MODULARITY AND SCALEABILITY



With GRAM GASTRO 07 & 08 you can build your own work place. Choose your combination of work top, doors and drawers, legs or castors or electric elevation, temperature ranges and accessories.

EASY MAINTENANCE AND SERVICE



A compact slide-out refrigeration unit for easy maintenance and service access. Removable and easy to clean condenser filters and gaskets.

HIGH STANDARD IN HYGIENE



Designed for easy cleaning with smooth surfaces throughout. Specific other features are highlighted above.

PRODUCT LINE-UP

70 CM DEEP. 1/1 GASTRONORM. NUMEROUS APPLICATIONS.

A WIDE VARIETY OF OPTIONS

GASTRO 07 ADAPTS TO YOUR WORKING DAY

Start configuring your GASTRO 07 Counter:

- Available with three temperature ranges
- Available with two, three or four sections
- Worktop options as shown
- Doors, 2/2 drawers sets or 3/3 drawer sets (no drawers for freezer counters or Prep Top worktop)
- With or without lock
- Legs, castors, plinth mounted or electric elevation
- Built-in or remote refrigeration system
- Rack with 2 shelves can be fitted onto the worktop

LEGS, CASTORS OR PLINTH MOUNTING



L1: 100 - 130 mm - **L2** (standard): 135 - 200 mm

L3: 185 - 250 mm - **C1:** castors 127 mm

C2: castors 155 mm

Prepared for plinth mounting at no extra charge.

MATERIALS & COMBINATIONS

EXTERIOR

Stainless steel **C**

INTERIOR

Stainless steel **C**

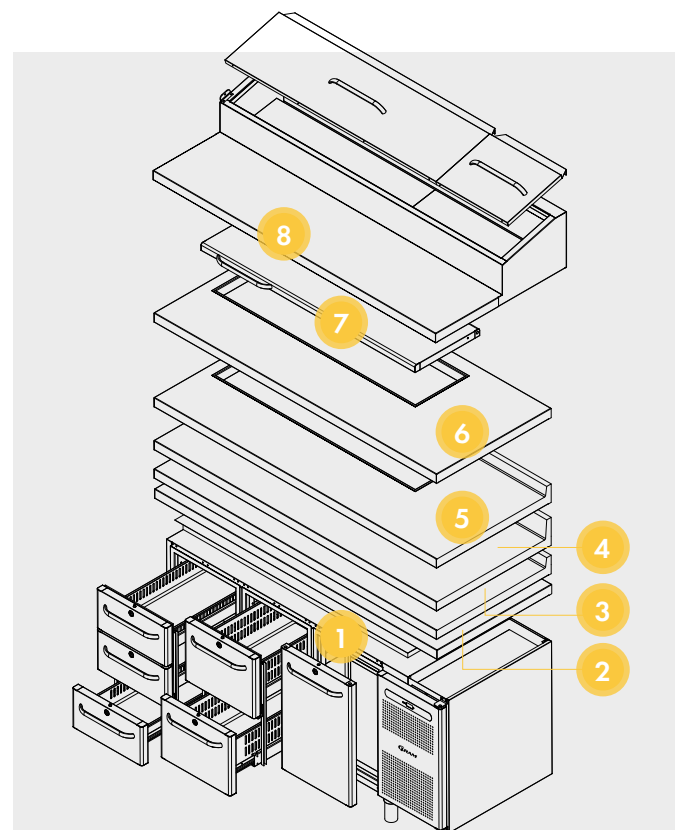

WORKTOP OPTIONS

1. | Insulation board (i.e. without work top)
2. | Flat worktop without splashback
3. | Flat worktop with 50 mm splashback
4. | Flat worktop with 100 mm splashback
5. | Saladette worktop with 50 mm splashback
6. | Saladette worktop without splashback
7. | Insulated lid or acrylic lid for saladette worktop
8. | Prep Top worktop with night lid

Stainless steel is nickel-free



GASTRO 1407

(2 sections)

ENERGY RATING of configuration shown

☼ Refrigerator (K) **D** (M) **E**



GASTRO 1807

(3 sections)

ENERGY RATING of configuration shown

☼ Refrigerator (K) **D** (M) **E**



GASTRO 2207

(4 sections)

ENERGY RATING of configuration shown

☼ Refrigerator (K) **D** (M: not with drawers)



GASTRO 07 SALADETTE

(2/3/4 sections, doors only)

ENERGY RATING

(K) Not yet regulated



2 sections: W 1289 - 4 sections: W 2163



GASTRO 07 PREP TOP

(2/3/4 sections, doors only)

ENERGY RATING

(K) Not yet regulated



2 sections: W 1289 - 4 sections: W 2163



GASTRO 07 SNACK

(2/3 sections, drawers only)

ENERGY RATING

☼ Refrigerator (K) **C**



2 sections: W 1400

PRODUCT LINE-UP

80 CM DEEP. 2/1 GASTRONORM. PASS-THROUGH OR REACH-IN.

A SERVICE STATION OR A DOUBLE WORK STATION

BECAUSE EVERY KITCHEN IS DIFFERENT

Start configuring your GASTRO 08 Counter:

- Reach-in or pass-through double work station
- Available with 3 temperature ranges (pass-through only as refrigeration counters, K-models)
- Available with two or three sections
- Worktop options as shown
- Doors with or without lock
- Legs, castors, plinth mounted or electric elevation
- Built-in or remote refrigeration system
- Gantry with 2 shelves can be fitted onto the worktop

LEGS, CASTORS OR PLINTH MOUNTING



L1: 100 - 130 mm - **L2** (standard): 135 - 200 mm

L3: 185 - 250 mm - **C1:** castors 127 mm

C2: castors 155 mm

Prepared for plinth mounting at no extra charge.

MATERIALS & COMBINATIONS

EXTERIOR

Stainless steel **C**

INTERIOR

Stainless steel **C**

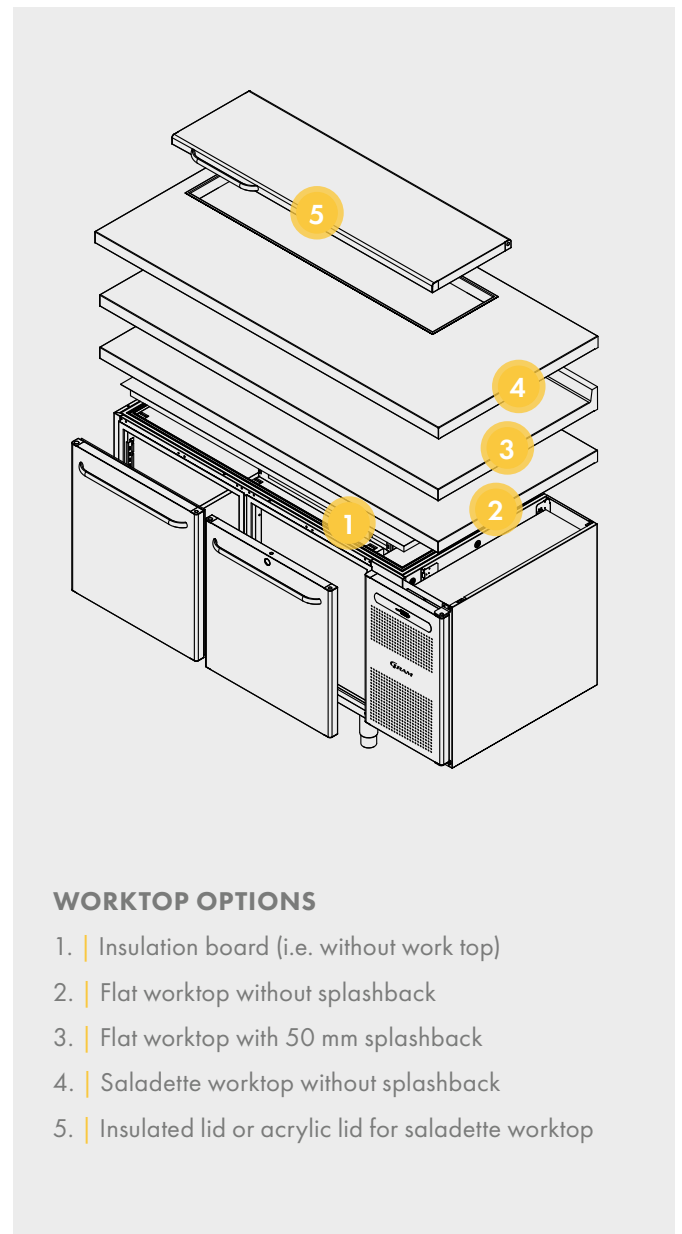

WORKTOP OPTIONS

1. | Insulation board (i.e. without work top)
2. | Flat worktop without splashback
3. | Flat worktop with 50 mm splashback
4. | Saladette worktop without splashback
5. | Insulated lid or acrylic lid for saladette worktop

Stainless steel is nickel-free



GRAM GASTRO 08



GASTRO 1808
(2 sections) REACH-IN

ENERGY RATING

☼ Refrigerator (K) **C** (M) **D** (F) **F**



GASTRO 2408
(3 sections) REACH-IN

ENERGY RATING

☼ Refrigerator (K) **D** (M) **E**



GASTRO 1808/2408 SALADETTE
(2/3 sections) REACH-IN

ENERGY RATING

(K) Not yet regulated



2 sections: W 1700



GASTRO 1808 D
(2 sections) PASS-THROUGH

ENERGY RATING

(K) Not yet regulated



GASTRO 2408 D
(3 sections) PASS-THROUGH

ENERGY RATING

(K) Not yet regulated



GASTRO 1808/2408 D SALADETTE W/GANTRY
(2/3 sections) PASS-THROUGH

ENERGY RATING

(K) Not yet regulated



2 sections: W 1700

PRODUCT LINE-UP

RELIABLE. DURABLE.
AFFORDABLE.

QUALITY COOLING TO RELY ON

The Snowflake GII series was developed out of the dedication to serve those who work under pressure, in the heat of a commercial kitchen with limited space – every day.

The series comprises single and double door refrigerators and freezers, refrigerated counters and blastchillers/freezers.

The Snowflake GII range is manufactured utilising the best engineering, design technologies and strict quality assurance from our teams in Denmark and Japan.

HYGIENIC AND ERGONOMIC FEATURES

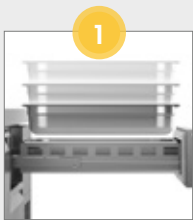

1
Extra-long drawer telescopic rails.

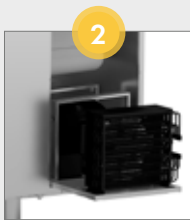

2
Cleaning-free extractable condenser.

Work top with splashback for spillage control (optional).



MATERIALS

EXTERIOR

Stainless steel **C**
AISI 304

INTERIOR

Stainless steel **C**
AISI 304

Stainless steel is nickel-free

Optional 2 and 3 drawer sections:

▬ W 330 x D 543 x H 201 mm (inside)

▬ W 330 x D 543 x H 101 mm (inside)

TEMPERATURE RANGE

K
-2/+8°C

Refrigerator

USAGE AREAS



Catering Healthcare* Education Hospitality Leisure

*Food storage only, not for bio-medical purposes

- ✓ Generally popular for commercial kitchens/back of house and for front of house kitchens within hospitality businesses
- ✓ Heavy Duty cabinets: climate class 5. Suitable the ambient temperatures of up to +40°C (tropical)



SCR 130/180/225 CGRC (2/3/4 sections) REACH-IN

ENERGY RATING

Refrigerator (K) **C**



1/1 GN DEEP

2 sections: W 1314 - 3 sections: W 1780

HIGH STANDARD IN HYGIENE



Interior and exterior: anti-corrosion stainless steel. Suitable for humid locations. Base with rounded corners and removable gaskets for easy wiping. Work top with splashback for spillage control (optional).

EASY MAINTENANCE AND SERVICE



Cleaning-free extractable condenser lowers maintenance costs, eases service and ensure stable performance.

HIGHLY CONFIGURABLE



Configurable with the option of combining with flat work top or with 100 mm splashback and multiple door-drawer combinations. (Contact your local sales office for a specified quotation).

SUSTAINABLE AND EFFICIENT



This series has a low energy consumption, uses natural refrigerants and is future proof.

CONTROLLING AND MONITORING CRITICAL FOOD TEMPERATURES



GRAM KPS 90

Multifunctional Gram quick-chillers on page 46



MASTERING THE ART OF TEMPERATURE CONTROL

Blast chilling and freezing are integral parts of any cook-chill operation in food production. Possibilities to immediately chill or freeze cooked food for safe storage.

The GRAM KPS series has been designed to cover all regulations around the perfectly hygienic transition from cooking to chilling your valuable produce. With capacities ranging from 22 kg to 180 kg for blast chillers and 13 to 180 kg for blast freezers, this series offers suitable options for various kitchen layouts and purposes.

BLAST CHILL PRODUCTION OF FOOD



BLAST FREEZE PRODUCTION OF FOOD





GRAM KPS BLAST CHILLERS/FREEZERS

REACH-IN, ROLL-IN OR ROLL-THROUGH

Our goal is to always cater to the individual processes and requirements that come with different segments, guest capacities or space limitations. That is why this series offers a number of outstanding options.

 REACH-IN models:
KPS 21, 42

 ROLL-IN models:
KPS 60, 90, 120, 180

 ROLL-THROUGH models:
KPS 120, 180

MODULARITY FOR INDIVIDUAL NEEDS

The largest blast chillers/freezers KPS 120 and 180 are available as modules to suit individual needs:

MODULE 1: NO ROOM

Includes electronic controller and the evaporator unit.

MODULE 2: EXTENDED PACKAGE INCL. ROOM

This option includes a Gram room which ensures full compatibility with the evaporator unit.

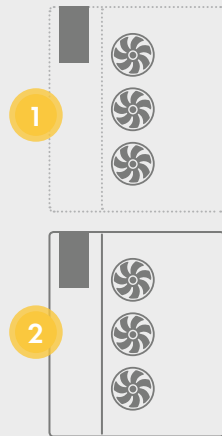

MODULE 3: FULL PACKAGE

This option also includes the refrigeration unit and assembly.

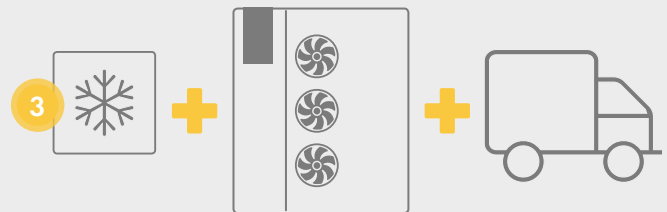

NB: Module 3 is not available for all markets. Please contact our customer service.

USAGE AREAS



Catering Healthcare* Education Hospitality Leisure

*Food storage only, not for bio-medical purposes

✓ This series is often chosen by restaurants, production kitchens or food production facilities which require efficient and effective methods to chill down and freeze already portioned food - always on point, with taste and texture always perfectly protected throughout the entire process.

FOOD SAFE

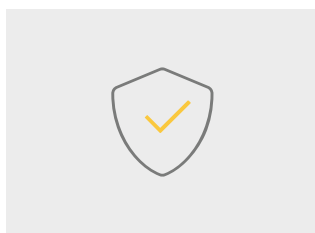

Food items handled in full compliance with the HACCP guidelines. HACCP alarms and an automatic shift to 'storage mode' are useful extras to help you to ensure highest food safety at all times.

HIGH FOOD QUALITY



Taste, texture, appearance as well as vitamins and nutrient content are preserved. Use of IFR function also protects against surface freeze damage.

VERSATILITY

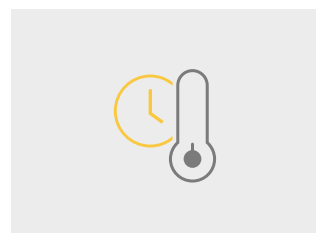

Offers different operational modes: IFR operation, time or temperature controlled chill cycle. Up to 20 customized cycles can be stored.

MODULARITY AND SCALEABILITY

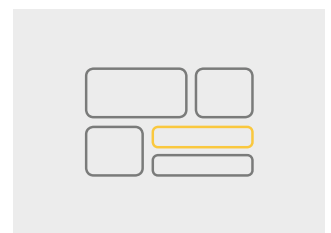

Capacities from 13 to 180 kg of food. Reach-in, roll-in or roll-through models for small or big scale operations. Part delivery or turn key.

PRODUCT LINE-UP

INTELLIGENT FOOD RECOGNITION - IFR

YOUR PRODUCTS DESERVE THE BEST IN PACE, POWER AND PROTECTION

With the IFR control system it has never been easier to control food temperatures and chilling times when running a blast chilling cycle - without any risk of surface freezing damage. Simply press the IFR short cut button and the blast chilling cycle is automatically adapted to the food item's characteristics. This means the food items are brought safely through the high risk temperature range of +65°C and +10°C while maintaining taste and appearance.

SAFE AND EASY HANDLING OF YOUR FOOD

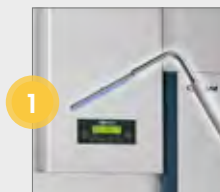

Multipoint sensor with 3 measuring points: temperature at the core, beneath the surface and on the surface of the food.

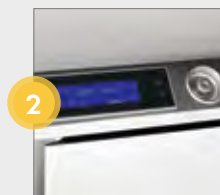

KPS 21 and 42 with encoder wheel for easy and intuitive navigation.



Five short cuts: quick and safe operation with short cuts to most frequently used operations:

1. Defrosting cycle
2. IFR function
3. Blast chilling
4. Blast freezing cycle
5. Pre-cooling cycle.

MATERIALS

EXTERIOR

Stainless steel White finish L*

*KPS 120 and 180

INTERIOR

Stainless steel Stainless steel

Stainless steel is nickel-free



LEGS

KPS 21: 80 mm - KPS 42: 150 mm
KPS 90-SF1: 295 mm - KPS 90-SF2: 225 mm

BLAST CHILLING/FREEZING COMBINATIONS

- CH Blast Chiller with built-in compressor
- SH Blast Chiller/Freezer with built-in compressor
- CF Blast Chiller for remote connection
- SF Blast Chiller/Freezer for remote connection

GRAM KPS BLAST CHILLERS/FREEZERS



CH SH

KPS 21 REACH-IN



CAPACITY

- Chilling: 22 kg
- Freezing: 13 kg

Rack: **5** positions for 1/1 GN & 40 x 60 cm bakery plates



CH SH
CF SF

KPS 42 REACH-IN



CAPACITY

- Chilling: 45 kg
- Freezing: 27 kg

Rack: **10** positions for 1/1 GN & 40 x 60 cm bakery plates



CH
CF

KPS 60 ROLL-IN

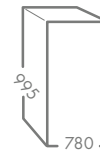

CAPACITY

- Chilling: 60 kg

Trolley for Rack: **16** positions for shelves 1/1 GN (optional)



SF

KPS 90 SF-1/SF-2 ROLL-IN



CAPACITY

- Chilling: 90 kg
- Freezing: 50 kg

Oven trolley capacity: **20** x 1/1 GN trolleys*



CF SF

KPS 120 ROLL-IN/ROLL-THROUGH



CAPACITY

- Chilling: 120 kg
- Freezing: 120 kg



CF SF

KPS 180 ROLL-IN/ROLL-THROUGH

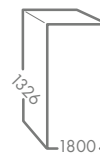

CAPACITY

- Chilling: 180 kg
- Freezing: 180 kg

* Oven trolley compatibility: Rational CPC 201 (SF-1) - Hounö Type 1.16/1.20 (SF-1) - Rational SCC 201 (SF-2)

PRODUCT LINE-UP

ESSENTIALS FOR CONVENIENCE AND TASTE

RELIABLE. DURABLE. AFFORDABLE.

Snowflake Blast Chillers and Freezers were designed with a strong focus on the real essentials: durable materials, sturdy design, perfect performance and instant convenience, when it comes to cleaning and maintenance.

THE PROTECTIVE MODE : HARD AND SOFT CHILL

Cycles in HARD and SOFT mode are available to regard all types of food. Snowflake blast chillers can be operated in both 'Hard Chill' and 'Soft Chill' - mode and therefore suitable for a diversity of produce and foods.

LEGS
SBU 15 & SBU 20: 75-108 mm
SBU 40: 105-155 mm

MATERIALS & COMBINATIONS

EXTERIOR

Stainless steel **C**

INTERIOR

Stainless steel **C**

Stainless steel is AISI 304

ALWAYS ON POINT

This series is often chosen by restaurants, production kitchens or food production facilities which require efficient and effective methods to chill down and freeze already portioned food - always on point, with taste and texture always perfectly protected throughout the entire process.

USAGE AREAS



Catering Healthcare* Education Hospitality Leisure

*Food storage only, not for bio-medical purposes

FOOD SAFE



As soon as a user places food inside the blast chiller, a fully automatic time cycle starts. No action required - after the chilling process has finished, the device automatically shifts from 'chilling mode' to 'storage mode'.

EASY CLEANING

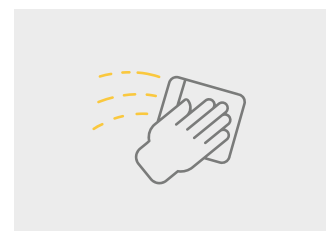

Durable and easy-to-clean stainless steel and smooth surfaces with rounded internal corners to keep the device hygienically clean. Evaporator and fan easily accessible. Both door gasket and shelf-support can be removed in an instant.

SNOWFLAKE BLAST CHILLERS/FREEZERS



SBU 15 HL

CAPACITY
 ❁ Chilling: 15 kg
 ❁ Freezing: 8 kg
 Rack: 5 positions for 1/1 GN



SBU 20 HL

CAPACITY
 ❁ Chilling: 20 kg
 ❁ Freezing: 12 kg
 Rack: 5 positions for 1/1 GN



SBU 20 HT

CAPACITY
 ❁ Chilling: 20 kg
 ❁ Freezing: 12 kg
 Rack: 5 positions for 1/1 GN



SBU 40 HT

CAPACITY
 ❁ Chilling: 42 kg
 ❁ Freezing: 25 kg
 Rack: 10 positions for 1/1 GN

PRODUCT LINE-UP

MULTIFUNCTIONAL CABINETS

'6-IN-1' CABINETS

Gram Quick Chillers are true multifunctional cabinets. Sophisticated electronic controls offer the choice of six different functions:

1. REFRIGERATION
2. FREEZING
3. QUICK CHILL
4. QUICK FREEZE
5. CONTROLLED THAWING
6. DRY COOLING

LEGS, CASTORS OR PLINTH MOUNTING
L1: 100 - 130 mm - L2 (standard): 135 - 200 mm
C1: castors 110 mm - C2: castors 125 mm
Prepared for plinth mounting at no extra charge.

MATERIALS & COMBINATIONS

EXTERIOR

Stainless steel **C**

INTERIOR

Stainless steel **C**

Stainless steel is AISI 304

✓ This series is typically selected by operations which need a less powerful device than a classic blast chiller, but seek to benefit from the versatility provided by a quick chiller.

TEMPERATURE RANGE

STORAGE -25/+10°C	QUICK CHILL -30/+10°C
----------------------	--------------------------

USAGE AREAS



Catering Healthcare* Education Hospitality Leisure

*Food storage only, not for bio-medical purposes



GRAM QUICK CHILLERS/FREEZERS



KP 60 QUICK CHILLER



KP 82 QUICK CHILLER

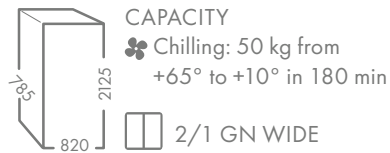

U/KP 82 COMBI CABINET



Smart Double Function:

This model can be operated as both quick chiller and storage cabinet. Storage with 'universal' temperature range is built into the upper section.



MULTIFUNCTIONAL

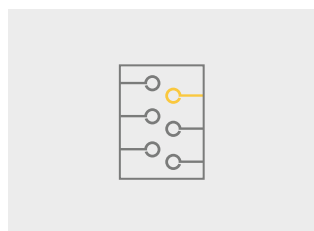

All in One. Multi-purpose cabinet with SIX operation modes. Outside of a chilling or freezing process it can simply be used as a storage refrigerator or freezer.

FOOD SAFE

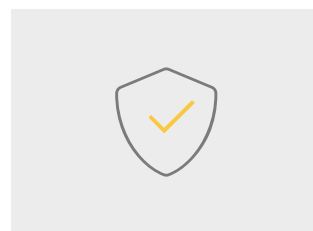

Maintaining safe temperatures with an efficient air circulation system, which also assures fast temperature recovery each time the door was opened.

EASY TO OPERATE

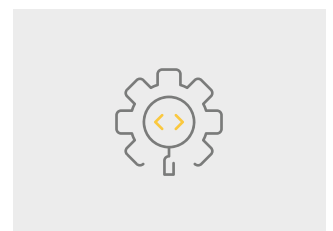

This series provides time or temperature controlled chilling/freezing processes. Preset programs can be operated directly via the display to run either 'Soft Chill' for a gradual chilling or 'Hard Chill' for fast rapid freezing.

SERVING BAKERIES
FOR **GENERATIONS**

HANDLING OF DELICATE HIGH QUALITY BAKERY PRODUCTS

Generations of bakeries, confectioners and patisseries are trusting GRAM BAKER storage and process cabinets their high quality bakery products. This is a great privilege and a daily inspiration for us. The GRAM BAKER range offers a complete series of refrigerators, freezers, quick chillers and probers.

Thanks to the GRAM air circulation system a correct and uniform temperature and humidity is ensured throughout the inside cabinet. The air is exhausted and refrigerated and then directed back into the inside cabinet, circulating around all food items. Thus, unwanted dehydration and skin forming of the goods is almost excluded.

*For successful
baking traditions*



*3 generations of Gram Baker
cabinets that have equipped
European bakeries since 1991.*



HANDLING YOUR BAKERY PRODUCTS WITH TECHNOLOGICAL INNOVATIONS



BAKER GA 950

QUICK GUIDE

- ✓ Special Features: ideal for bakeries, confectioners and patisseries
- ✓ High Performance: perfect storage conditions despite frequented door openings
- ✓ Perfect Fit: meets standard bakery tray size requirements
- ✓ BAKER 625, 550, 950, 1500, 1808/2408 Quick Chiller/Freezers (SF), Freezer-Retarder-Provers (GA): ideal for heavy-duty operations, rated with Climate Class 5 and suitable for the use in ambient temperatures of up to +40°C
- ✓ BAKER 610: ideal for normal-duty operations, rated with Climate Class 4, and suitable for the use in ambient temperatures of up to +30°C

TEMPERATURE RANGES

M	F	SF	GA
-5/+12°C	-25/-5°C	-30/+10°C	-25/+40°C
Refrigerator, Storage cabinets and counters	Freezer, Storage cabinets and counters	Quick Chiller/Freezer	Refrigerator/Freezer/Prover

INNOVATIONS IN DETAIL...

1. | Standard with coated evaporator; durable and saves costs later
2. | Controls concealed behind the top panel, protected against splashing water
3. | Standard models are supplied with an integral door lock
4. | Full length aluminium profiles impart additional strength and durability
5. | Removable door gasket for easy cleaning
6. | Self-closing door; remains open at opening angles more than 90°
7. | Support rails for bakery trays. These can be individually positioned
8. | Patented pedal door opener. Same opener can be placed left or right side



Top view of the profile



Inside door handle:
2 mm aluminium profile

USAGE AREA



Bakery, Confectioners and Patisseries

LEGS, CASTORS OR PLINTH MOUNTING



L1: 100 - 130 mm - **L2 (standard):** 135 - 200 mm

C1 (standard): castors 110 mm - **C2:** castors 125 mm

Prepared for plinth mounting at no extra charge.

PRESERVING QUALITY



Both storage and process cabinets come with built-in functionalities that preserve the quality of your bakery products at all times.

Find more information on the following pages.

LOW-RUNNING COSTS



The energy-efficient refrigeration technology implemented in this wide line-up of storage cabinets can help saving running costs on a everyday basis.

BUILT-IN SAFETY



Controller equipped with safety functions: Door alarm, alarms for high temperature or when condenser filter cleaning is needed to avoid overheating. Controller perfectly protected from water splashes behind top panel.

MULTI-FUNCTIONAL



The SF can be used as quick chiller/freezer, storage freezer, storage refrigerator, or thawing cabinet. It is equipped with a dry cooling function. As required, The GA can be also used continuously as freezer, as refrigerator or as prover.

PRODUCT LINE-UP

STREAMLINED APPLICATIONS WITH ALL THE GRAM ADVANTAGES

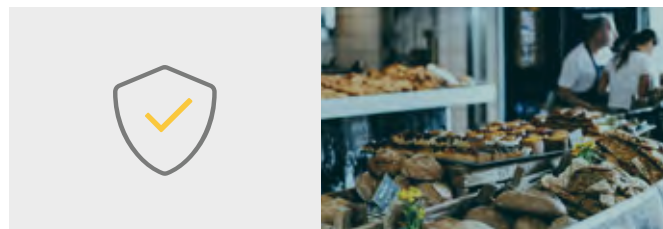

MODERN DESIGN PRINCIPLES & INVENTIVE TECHNOLOGY

GRAM BAKER refrigerators and freezers are based on our award winning design principles and innovative solutions. Essential is an efficient air circulation system, providing indirect cooling and temperature stability and protecting your bakery products. Additionally, the electronic controls have safety functions for optimum protection.

REACH-IN OR ROLL-IN:

The BAKER range offers also roll-in cabinets. The BAKER 1500 series is available as refrigerator or freezer for bakery trolleys.

PRESERVING YOUR QUALITY BAKERY PRODUCTS

Our refrigerators prevent any undesirable drying out of the bakery products thanks to indirect airflow of the air distribution system. You can use the dry cooling function for lower humidity (M cabinets), or use thawing function for controlled thawing.

Our refrigeration technology has been developed to prevent any undesirable quality loss of your products, such as drying-out of dough and cakes.



MATERIALS & COMBINATIONS

EXTERIOR

Stainless steel **C**

Stainless steel **C**

White finish **L**

INTERIOR

Stainless steel **C**

ABS grey **ABS***

Stainless steel **C**
ABS grey **ABS***

Stainless steel is nickel-free. *Only BAKER 610

GRAM STORAGE CABINETS & COUNTERS



BAKER 610

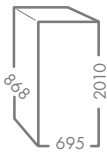

ENERGY RATING

- ☼ Refrigerator **C**
- ❄ Freezer **E**

Incl. **10** sets of bakery supports
Tray size: 40 x 60 cm



BAKER 625

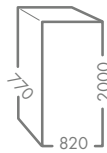

ENERGY RATING

- ☼ Refrigerator **B**
- ❄ Freezer **C**

Incl. **20** sets of bakery supports
Tray size: 60 x 40 cm



BAKER 550

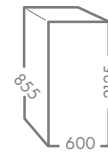

ENERGY RATING

- ☼ Refrigerator **B**
- ❄ Freezer **C**

Incl. **25** sets of bakery supports
Tray size: 40 x 60 cm



BAKER 950

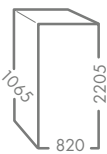

ENERGY RATING

- ☼ Refrigerator **C**
- ❄ Freezer **D**

Incl. **25** sets of bakery supports
Tray size: 60 x 80/40 cm



BAKER 1500 ROLL-IN

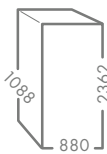

ENERGY RATING

Not yet regulated

For bakery trolleys



BAKER 1808/2408 (2/3 sections)

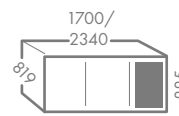

ENERGY RATING

- ☼ Refrigerator **E F**
- ❄ Freezer 1808 **F**

Incl. 2/3 x **9** sets of bakery supports
Tray size: 40 x 60 cm

PRODUCT LINE-UP

WORKFLOW CONVENIENCE AND OPTIMAL PROCESS SUPPORT



GA SERIES

The GRAM GA cabinet is a computer-controlled refrigerator/freezer/prover with individual program settings.

Set the GA to prove the dough outside working hours. The GA with its steam generator will automatically take the dough through all processes; from frozen or refrigerated dough to proved dough using your temperature, humidity and time settings. The air circulation system provides indirect cooling and temperature stability, protecting your bakery products. Skin-forming or drying-out of products can be eliminated almost entirely.

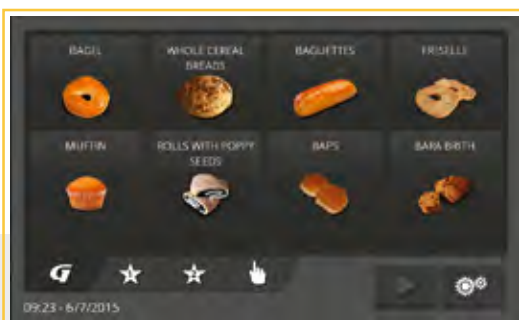

GA TOUCH DISPLAY CONTROLLER:

The 7-inch touch intuitive display controller is very easy to use and provides a clear overview of the current process status at all times. The operator can choose between 8 pre-set standard programs for easy start-up. Additionally, the intuitive controller allows manual program setting for individual adjustments.

SF SERIES

The SF series comprises multi-functional cabinets. The SF can be used as quick chiller/freezer, storage freezer, storage refrigerator, thawing cabinet and with dry cooling function.

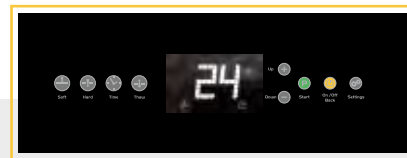

QUICK CHILLER/FREEZER CONTROLLER:

Multiple operation modes – use as quick chiller/freezer or choose refrigeration or freezing storage mode. The SF series features a large display, so the ongoing process is easy to monitor.

ROLL-IN FOR BAKERY TROLLIES:

The BAKER SF 1500 is a quick chiller/freezer for bakery trollies. The material used is stainless steel and it comes with a heated floor and a drive-in ramp.



MATERIALS & COMBINATIONS

EXTERIOR

Stainless steel
Nickel-free

INTERIOR

Stainless steel
Nickel-free

GRAM PROCESS CABINETS



BAKER SF 550

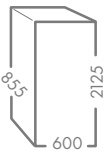

ENERGY RATING
Not yet regulated

Incl. **25** sets of bakery supports
Tray size: 40 x 60 cm



BAKER SF 950

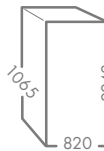

ENERGY RATING
Not yet regulated

Incl. **25** sets of bakery supports
Tray size: 60 x 80/40 cm

Not yet available
with natural
refrigerants



BAKER SF 1500

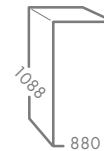

ENERGY RATING
Not yet regulated

For bakery trolleys

Not yet available
with natural
refrigerants



BAKER GA 550

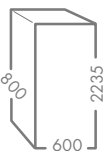

ENERGY RATING
Not yet regulated

Incl. **25** sets of bakery supports
Tray size: 40 x 60 cm



BAKER GA 950

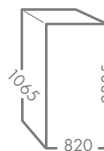

ENERGY RATING
Not yet regulated

Incl. **25** sets of bakery supports
Tray size: 60 x 80/40 cm



MARINE

**FOR THE
DEMANDING
CONDITIONS OF
MARINE KITCHENS**

RELIABLE, SAFE, STURDY

GRAM MARINE cabinets and counters are specially designed for the rugged needs of a working marine environment where reliability, performance and safety are the primary considerations. Upright cabinets, counters or under counters in different sizes and specifications.



BUILT-IN SAFETY OF GRAM MARINE

All GRAM MARINE shelves are fixed to the supports to ensure no movement during heavy sea conditions, when the door is open. In calm seas the shelf can be turned easily allowing the shelves to be pulled out. Safe and convenient.



Security in heavy seas



OUTSTANDING REFRIGERATION SOLUTIONS FOR MARINE KITCHENS



MARINE PLUS 70

FRESHNESS IN DEMANDING ENVIRONMENTS: MARINE CABINETS AND COUNTERS

For decades, Gram has manufactured and supplied specialized refrigeration solutions for the offshore and marine sectors. These customers require our fully adapted models of the ECO MARINE series.

No matter what specification you require, Gram marine equipment – uprights and counters - provides reliable, safe and sturdy solutions.

- ✓ Designed for the rough conditions and work mode of a vessel kitchen, where reliability, performance and safety are the primary considerations. Insulation class: IP21
- ✓ With different foot print sizes and gross volumes from 125 to 614 litres, there is a cabinet for almost any professional galley. 230V/60Hz compressor as standard or 230V/50Hz at no extra costs

MARINE LEGS

130-200 mm. Can be fixed to the floor.

- ✓ Heavy duty, Climate Class 5: PLUS, TWIN and MIDI with insulated door
- ✓ Normal duty, Climate Class 4: COMPACT 210, 310, 410 with insulated door, MIDI cabinets and COMPACT 610 with glass door
- ✓ Climate Class 3: COMPACT 210, 310 and 410 with glass door

KEY FEATURES: PLUS, TWIN AND MIDI

1. Safe and cleaning friendly. Controls are concealed behind the top panel, perfectly protected against splashing water
2. 50Hz or 60Hz compressor: This gives you maximum flexibility at no extra charge
3. Food safe: temperature stability at all times, thanks to innovative air circulation system
4. Easy cleaning: removable door gaskets for easy cleaning
5. Specialized elements: dedicated locking marine handle
6. Durable: sturdy stainless marine shelves with front and rear edge
7. Anti-allergic materials: nickle-free stainless steel
8. Easy wiping: Inside base with rounded corners and smooth surfaces help keeping the device hygienically clean
9. Stability: marine legs can be fixed to the marine floor for maximum security



MAXIMUM SECURITY AT HEAVY SEAS
All marine shelves are fixed to the supports to ensure no movement during heavy sea conditions. In calm seas the shelves can be turned easily allowing to be pulled out.



USAGE AREA



Marine

TEMPERATURE RANGES

K	M	F	F
+2/+12°C	-5/+12°C	-22/-5°C	-25/-5°C
Refrigerator	Fresh meat/ fish cabinet	Freezer*	Freezer**

*COMPACT 210, 310, 410 ** PLUS, TWIN, EURO, MIDI, GASTRO, COMPACT 610

GLASS DOOR CONVENIENCE
Glass door alternative for good overview and convenience. Available for some cabinets.



MATERIALS & COMBINATIONS

PLUS, TWIN, MIDI, GASTRO

ALL SERIES

EXTERIOR

Stainless steel **C**

INTERIOR

Stainless steel **C**

COMPACT, SOLID DOOR

COMPACT 210, 310, 410, 610

EXTERIOR

Stainless steel **C**

INTERIOR

ABS grey **ABS**

COMPACT GLASS DOOR

COMPACT 210, 310, 410
COMPACT 610

EXTERIOR

Stainless steel **R**

Stainless steel **R**

INTERIOR

ABS white **ABS**

ABS grey **ABS**

Stainless steel is nickel-free

PRODUCT LINE-UP

MARINE COUNTERS & CABINETS



WORK TOP OPTIONS

1. | Insulation board (i.e. without work top)
 2. | Flat worktop without splashback
 3. | Flat worktop with 50 mm splashback
 4. | Flat worktop with 100 mm splashback
 5. | Saladette worktop with 50 mm splashback
 6. | Saladette worktop with or without night lid
- In addition, a rack with 2 shelves can be fitted onto the worktop.

MARINE COUNTERS 1/1 GN - 2/3/4 REFRIGERATED SECTIONS

Refrigerators (K-models) have two drawer set options per section:

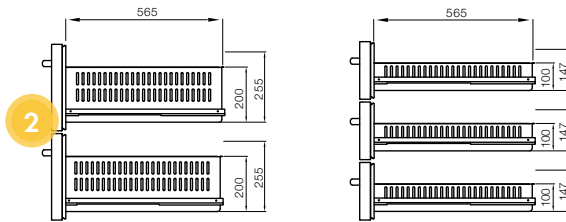

Counter tops are fitted with 'Marine edge' to prevent liquids from reaching the underlying cabinet.

COMPACT CABINETS SMALL FOOTPRINT OR 2/1 GN DEEP

COMPACT 210, 310 and 410 – small footprint, only 595 x 640 mm or choose COMPACT 610 for GN 2/1 deep compatibility.*



One piece ABS inner lining, easy to clean.



*For more details see COMPACT section at page 24.

GRAM MARINE COUNTERS & CABINETS



COUNTERS 1407/1807/2207
(2/3/4 sections) 1/1 GN DEEP

ENERGY RATING
Not yet regulated



1/1 GN DEEP
SHELF 32.5 x 53 cm

2 sections: W 1289 - 4 sections: W 2163



COMPACT 210/310/410/610

ENERGY RATING
Not yet regulated

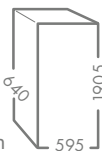

SHELF 48.6 x 43,3 cm
BOTTOM 48.6 x 30 cm
610 SHELF: 53 x 65 cm

210: H 830 - 310: H 1320 - 610: W 695 x D 868 x H 2005



Top-mount
compressor

MARINE PLUS 70

ENERGY RATING
Not yet regulated

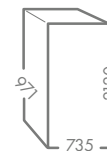

2/1 GN DEEP
SHELF: 53 x 65 cm

Dim. including handle



Top-mount
compressor

MARINE TWIN 82

ENERGY RATING
Not yet regulated

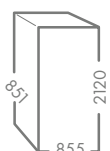

2/1 GN WIDE
SHELF: 65 x 53 cm

Dim. including handle



Bottom-mount
compressor

MARINE MIDI 60

ENERGY RATING
Not yet regulated

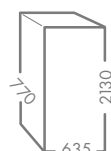

SHELF: 43.5 x 53 cm

Dim. including handle



Bottom-mount
compressor

MARINE MIDI 82

ENERGY RATING
Not yet regulated

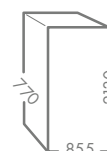

2/1 GN WIDE
SHELF: 65 x 53 cm

Dim. including handle

WHAT INSPIRES ME ABOUT
BEING A **BARTENDER** IS
THE ENDLESS POSSIBILITIES
IN TASTE AND TEXTURE

Tess Posthumus

PREMIUM ICE FOR ALL PURPOSES

As a fully integrated manufacturer and supplier of commercial refrigeration solutions and ice makers, we are proud to have built a comprehensive portfolio of ice makers, suitable for all types of businesses and purposes.

Our product line up ranges from Cubers, Flakers, Nugget and Crescent Ice Makers to Special Ice Makers, producing extraordinary ice shapes such as ball ice, heart ice or star ice.

*“For a perfect cocktail
I want to use only clear,
hard and tasteless ice.”*

Tess Posthumus

Co-Owner of Flying Dutchman Cocktails
Amsterdam and Hoshizaki Ambassador

Hoshizaki Ice Makers continuously excel in meeting even the highest hygiene and contamination protection standards. That is why Hoshizaki ice can not only be found in bars, restaurants, supermarkets and hotels, but also in healthcare facilities, hospitals, laboratories and research institutions all over the world.



“One of the most essential elements to recovery for a professional diver is ice.”



ICE AIDS RECOVERY AT DIVE LONDON AQUATICS CLUB

Jane settled at Dive London in 2014, after having coached diving teams all around the world. As an experienced coach, she knows how vital the recovery phase is for the divers. An integral part of the recovery is eliminating muscle soreness, for instance by keeping the muscles cold in order to limit the swelling. This is especially beneficial for divers who engage in the '10 meters'.

From big names such as Tom Daley, Grace Reid, and Robert Birch to the up and coming juniors of the Club - Hoshizaki ice became indispensable for every-day training days as well as competition days at Dive London.



“We fill small bags with ice, and use cling film to hold it tightly in place, generating a cold compression on the triceps and legs in particular. Left for 15-20 minutes, the ice really does deliver significant benefits to our team.”



LONDON AQUATICS CENTRE

QUEEN ELIZABETH OLYMPIC PARK, LONDON

Establishment

London Aquatics Centre, home to the Dive London Aquatics Club

Facilities

A one-stop shop for our athletes, with two indoor competition pools, a diving pool and state-of-the-art fitness facilities with a physio, therapy and rehab area

High Performance Head Coach

Jane Figueiredo

Opening year

As a legacy of the 2012 Summer Olympics and Paralympic games, facilities opened to the public on the 1st March 2014

Hoshizaki equipment

IM-45CNE Cuber

The centre is home to the Dive London Aquatics Club, which in conjunction with British Diving, offers a pathway for individuals looking to progress from the Tom Daley Diving Academy through, competing regionally, nationally and internationally. The club represents 72 divers (2018) with experience ranging from club level through to Olympic standard divers.



Before the Hoshizaki Cuber was installed, Jane and her team had to pre-order ice with external suppliers. Now, with their own ice maker they can rely on quality ice, on demand, at all times. This alone is a great asset, not only for training, but as well as competitions and events.





“The value Hoshizaki adds to the experience of my guests, far outweighs the initial investment.”



PRETTY DRINKS IN BEAUTIFUL GLASSWARE ...PERFECTLY CLEAR ICE

“Hoshizaki is the only company I’ve worked with that delivers a very consistent product, which I want and need - clear ice, every single time.”

“Supreme clarity is vital for the look of the finished drink. If the ice looks fantastic, it will showcase any of the wonderful products you choose to pair.”

Myles can look back on more than 20 years in the bar and drinks industry. Since his beginnings in mixology, he has been working with Hoshizaki Ice Makers exclusively, becoming a real Hoshizaki connoisseur over time.

“The machines are extremely reliable so they do not need regular attention, but service is always prompt and highly efficient”, the bar owner and bar consultant concludes.





THE MIXOLOGY GROUP

BRIGHTON, ENGLAND

Specialty

A drinks consultancy & training company

Establishment address

Rear of 64 Davigdor Road, Brighton

Founders

Myles Cunliffe set up the Mixology Group with his wife Zoe

Opening year

2010

Hoshizaki equipment

IM-240ANE-HC ice maker,
IM-65NE-Q Ball Ice maker

The Mixology Group specialises in training staff in all aspects concerning the bar business, from mixology and cocktails to bar tending and becoming a certified 'Whisky Ambassador'. The company also partners with big brands of new drinks when it comes to research & development of new beverages, mixtures and combinations. Last but not least, The Mixology Group is has made a name as a reliable provider of bar staff to all sorts of events, parties and celebrations.



When speaking about the importance of ice, Myles explains: "People underestimate the importance of truly great ice. As half the volume of the glass is made up of it, it is essential to have the clearest, densest ice possible. Watery, cloudy ice is simply not acceptable in a well made drink."



You will find two ice makers in the Brighton Bar "The Mixology Group", the classic IM Cuber and the famous Ball Ice Maker. "This is not only for the looks", explains Myles, "as with less surface area than square ice, round ice reduces melting time even more. And it looks spectacular in the glass."



“When it comes to ice making machines, we wouldn’t touch anything else.”

TRIPLE FILTERED SCOTTISH WATER & THE VERY BEST MACHINES

Supplying pre-bagged cubed and crushed ice in a choice of large 12 kg, or smaller 2 kg sealed bags, The Edinburgh Ice Co. offers delivery to anywhere in the UK.

Using a bank of sixteen Hoshizaki IM240 Ice Makers, the team can produce up to three tonnes of cubed ice per day at maximum capacity.

“Of course, we could use big, machines for mass ice production, but they simply don’t deliver the same results when it comes to quality of the ice. We’re all about the quality and will not compromise on anything less than a perfect ice cube or nugget.”





THE EDINBURGH ICE COMPANY

EDINBURGH, SCOTLAND

Specialty

Ice cubes for the hospitality and events sectors

Opening year

2014

Establishment address

1 Summerhall Pl, Edinburgh

Hoshizaki equipment

Sixteen Hoshizaki HC Cubers
IM-240ANE-HC

Founders

Ilanna Middleton and Rhys Ferguson

Started by a passionate duo, looking to fill a niche in the market for quality ice, the Edinburgh Ice Company initially started out by supplying bars, restaurants, hotels, festivals and events with ice for beverage making. With extensive experience of working in events and hospitality from their previous roles, Ilanna and Rhys had a solid prior knowledge of our city and its bars, pubs and high-profile events.



A talent for sculpting ice has unlocked opportunities around the country, especially as the only artisan ice carvers in Scotland.

Describing their business model, the owners explain: "We come to the rescue, when a bar or any other larger venue experiences a downtime or malfunction of their ice maker. Also, we supplement with highest quality ice, in the case of unexpected peak times and rush hours."

"We're super proud that we only use Hoshizaki machines for our cubed and crushed ice. In fact, we're so delighted; we put the Hoshizaki on our vans, uniforms, website, merchandise and in our social media content", Ilanna concludes.



THE SIX SIDES OF CHILLING PERFECTION

MEET THE HOSHIZAKI CUBE

Every bartender will tell you about the importance of the ice quality for their craft of creating layers of taste and texture in a cocktail glass. Premium spirits and ingredients simply ask to be paired with nothing less than ice cube perfection. Hoshizaki cubes are extremely compact, dry, tasteless, consistently identical and slowly melting, allowing just the right amount of dilution – a combination of everything a bartender requires when it comes to aesthetics, taste and functionality of ice.

THE MARBLE EFFECT:

The appearance of the Hoshizaki cube is characterized by its clean edges and its transparency streaked by a marbling effect. This effect occurs, when the **CELL WALLS** block the freezing water's expansion from all sides, while reaching up to -30°C during the cubing process. As the temperatures go down, the water keeps expanding and marbles start to form as a sign of extreme density and compactness of every single cube.

We are proud to provide and continuously perfect the technology behind these dense, dry and exceptionally hard ice cubes. As the cubes are formed individually inside **A CLOSED-CELL SYSTEM**, there is no unpleasant bridging between the single cubes.

CUBE SIZES

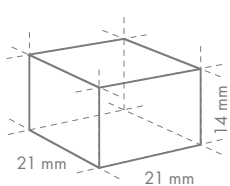

Cube size: **XS**
Weight: 6 g

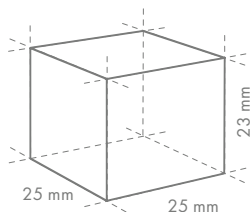

Cube Size: **S**
Weight: 13 g

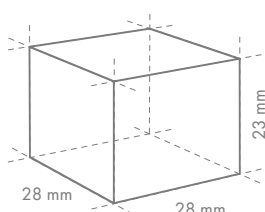

Cube Size: **M**
Weight: 17 g

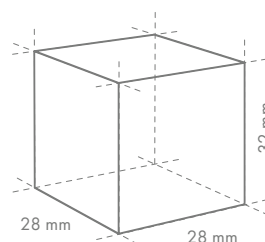

Cube Size: **L**
Weight: 23 g

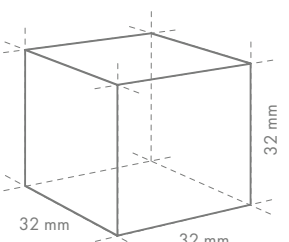

Cube Size: **XL**
Weight: 31 g

WHEN CREATING THE WORLD'S MOST POPULAR ICE CUBES, THERE ARE THREE MAJOR CHARACTERISTICS THAT COME INTO PLAY:

PERFECT TASTE



Being free of all impurities, our cubes are a perfectly tasteless chilling agent for all types of culinary purposes without compromising the taste of your creation.

PERFECT SHAPE



Each cube is made individually by a dedicated spray of fresh water within a closed cell to achieve the highest possible compactness of an ice cube with the perfectly precise square shape.

PERFECT DILUTION



During the freezing process, the cell walls block the freezing water's expansion from all sides. This makes Hoshizaki ice cubes so exceptionally compact and hard, that they provide the exact rate of dilution needed for cocktails and long drinks.

USAGE AREAS



Hospitality



Catering



Healthcare



Leisure



Marine



Education



Foodprocessing

LET'S COMPARE! UPGRADE NOW – AND CUT YOUR RUNNING COSTS!

Save up to
40%

	COMPETITOR 1	COMPETITOR 2	IM-30CNE-HC
⚡ Energy consumption	400 W/h	290 W/h	230 W/h
💧 Water consumption	0.09 m ³ /24h	0.13 m ³ /24h	0.07 m ³ /24h
<i>Total costs after 8 years*</i>	£ 4,814.-	£ 4,049.-	£ 2,926.-

	COMPETITOR 1	COMPETITOR 2	IM-240DNE-HC
⚡ Energy consumption	1850 W/h	1400 W/h	930 W/h
💧 Water consumption	0.37 m ³ /24h	0.40 m ³ /24h	0.32 m ³ /24h
<i>Total costs after 8 years*</i>	£ 21,866.-	£ 17,585.-	£ 12,150.-

We have compared our HC models against competitor models with identical production capacities.

*Electricity à £ 0.144/kWh - Water à £ 2.96/m³

THE DURABLE & DEPENDABLE HIGH PERFORMERS

ABOUT THE RANGE

All Cubers are equipped with an electronic control system. This ensures an optimized ice making process, even under varying circumstances. Without additional manual assistance or adjustments required, our Cubers produce generous amounts of ice cubes, at a consistent high quality. As all impurities are eliminated from the water right at the beginning of the cubing process, the problem of malfunction due to calcification, mineral accumulation and incrustation is almost unknown to owners of Hoshizaki Cubers. Thanks to natural refrigerant R290, all Cubers have an improved energy performance. Furthermore, naturally occurring HC refrigerants only have

a minimal global warming potential, compared to machines run with traditional HFC refrigerants. This has a positive impact on both the environment and your budget. As with all Hoshizaki Ice Makers, the Cubers are HACCP certified and known for continuously meeting the highest health, safety and hygiene standards.

As Hoshizaki Cubers come in multiple self-contained, modular & stackable options, the series is considered to be a true allrounder - suitable for all requirements, purposes, locations and budgets.

STABLE MATERIALS AND DURABLE DESIGN



The devices are designed to last and come with smart design extras such as a magnetic water pump without direct coupling. This element prevents leakage from the water circuit and improves the life expectancy of the device.

LOW ENERGY CONSUMPTION



The use of natural HC refrigerant R290 cuts down the overall energy consumption of our Cubers significantly.

RANGE PRODUCTION CAPACITY



The series consists of Cubers with production capacities, ranging from 22 - 240 kg per day.

HIGHEST HYGIENE STANDARDS & EASY MAINTENANCE



The exteriors are made of stainless steel. Also the closed water circuit provides maximum protection against any type of contamination during the entire cubing process. All Hoshizaki machines are easy to use, clean and maintain.



Self
contained

IM-21CNE-HC



Production capacity/24 h*:
25 kg
Bin capacity: 11.5 kg
Cube Size: **L**



Self
contained

IM-65NE-HC



Production capacity/24 h*:
62 kg
Bin capacity: 17 kg
Cube Size: **S L**



Self
contained

IM-100CNE-HC



Production capacity/24 h*:
105 kg
Bin capacity: 38 kg
Cube Size: **M L XL**



Self
contained

IM-240NE-HC



Production capacity/24 h*:
210 kg
Bin capacity: 110 kg
Cube Size: **L**



Modular

IM-240ANE-HC



Production capacity/24 h*:
210 kg
Cube Size: **XS M L XL**



Stackable

IM-240DNE-HC

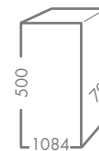

Production capacity/24 h*:
210 kg
Multiple machines can be stacked
Cube Size: **XS M L XL**

*Unless stated otherwise the indicated production capacity refers to the amounts produced by models with standard ice cube size L

MAXIMUM VERSATILITY FOR ENDLESS APPLICATIONS

FLAKE AND NUGGET ICE MAKERS

Our Flake and Nugget Ice Makers belong to the true allrounders of the Hoshizaki product line-up. These powerful, durable and sustainable machines are highly popular across different market segments, such as in food preparation/processing, as well as in hotels, bars, restaurants and catering businesses.

As the Flake and Nugget Ice Makers convert all water brought into the machine, the water consumption is equal

to its ice production. Additionally, all Flake and Nugget Ice Makers use the natural refrigerant R290, which is environmentally friendly and energy efficient.

Being proven free of all impurities and meeting even the strictest hygiene requirements, Hoshizaki flake ice is even used for organ transport and other medical purposes.

ICE-TO-WATER RATIO

The main characteristic of Hoshizaki's flake ice is that 'freeze burn' is prevented when displaying fresh fish or produce. The extruding head inside the Flaker exerts only a slight compression, producing the typical Hoshizaki ice flakes.

For Nugget ice, the extruding head performs a higher compression to yield **harder and dryer, individual** ice nuggets.

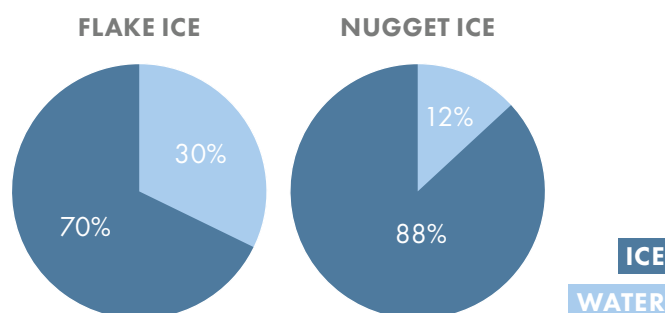



ABOUT FLAKE & NUGGET ICE

PERFECT TASTE AND HYGIENE



Being free of all impurities, our flake and nugget ice is a perfectly tasteless chilling agent for all types of culinary purposes. This factor makes this ice very popular for medical applications as well.

VERSATILITY



Hoshizaki ice makers can produce either flake or nugget ice. Both ice types are highly versatile and a staple for different market segments and business types, such as hotels, food production, bars and restaurants.

SUSTAINABILITY



All Flakers and Nugget ice makers use natural refrigerant R290, which is environmentally friendly and energy efficient. Additionally, it converts all fed-in water into ice and is therefore a device that can help you save water with every cycle.

USAGE AREAS



Hospitality



Catering



Healthcare



Marine



Foodprocessing



THE POWER TO CHILL - INDISPENSABLE ALL-ROUNDERS

ABOUT THE RANGE

An important design element of our Flaker technology is the extremely sturdy auger - the hardest working element of any flake ice maker. The inner workings of the Flake and Nugget Ice Makers is designed to prevent unpleasant incrustation, calcification and bacterial contamination inside and around the machine.

The auger is made of stainless steel, while carbon is used for the bearings. The durable materials used in their production help the machines to work optimally in wet and rough environments and allows proper and easy cleaning routines.

Benefits include: longer product life expectancy and reduced maintenance costs.

Hoshizaki ice makers have micro computer controls, monitoring the ice making process to perform at its best under varying circumstances, without having to make physical adjustments. An easily cleanable air filter allows operators to carry out frequented cleaning routines, which extends the product life expectancy and reduces the frequency and costs of maintenance call-outs.



Self contained



FM-80KE-HC/HCN



Production capacity/24 h:
Flake: 85 kg - Nugget: 75 kg
Bin capacity:
Flake: 26 kg - Nugget: 32 kg

Self contained



FM-120KE-HC/HCN



Production capacity/24 h:
Flake: 125 kg - Nugget: 110 kg
Bin capacity:
Flake: 26 kg - Nugget: 32 kg

Self contained



FM-120KE-50-HC/HCN



Production capacity/24 h:
Flake: 125 kg - Nugget: 110 kg
Bin capacity:
Flake: 57 kg - Nugget: 65 kg

Modular



FM-150AKE-HC-SB/HCN

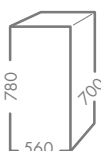

Production capacity/24 h:
Flake: 150 kg - Nugget: 140 kg

Modular



FM-300AKE-HC/HCN-SB

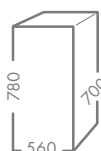

Production capacity/24 h:
Flake: 300 kg - Nugget: 250 kg

Modular



FM-480AKE-HC-SB/HCN-SB

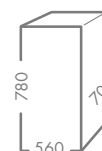

Production capacity/24 h:
Flake: 450 kg - Nugget: 380 kg



DISCOVER THE NEW GENERATION

UNIQUE PURITY - HOSHIZAKI'S SIGNATURE ICE ... WITH AN EDGE

Just like the original Crescent Ice Makers, the new generation with the 'Edge' produces clear, crescent shaped ice. The unique shape is built from the inside out with an internal temperature of -4°C and can be used for chilling drinks, produce and bottle display, as well as for cooking.

One of the most striking features of our Crescent Edge Ice is its round form and the flat bottom with two small winglets. This form behaves perfectly as drink chiller, as it is tasteless, absolutely clear, and slowly-melting.

Thanks to its rounded, yet edgy form, Hoshizaki Crescent Ice will also not cluster inside the ice chest, always ready to be scooped out easily for immediate use.

CRESCENT ICE

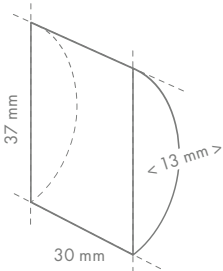

KM Cube
Weight: 9 g

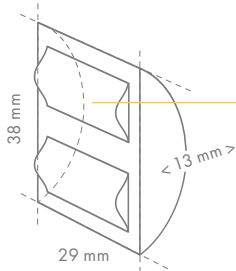

KM Edge Cube
Weight: 10 g

The new Crescent ice has **winglets**. Other than that, it has the same characteristics as the old version of KM. (i.e. Clarity, pureness, temperature, roundness)

ABOUT CRESCENT ICE



DAMAGELESS BOTTLE COOLING

The ice is hard and compact, but thanks to the smooth, round surface it is the ideal ice type to prevent damages to bottles and labels.



APPETIZING DISPLAY

Due to the crystal clear ice, you can present your produce completely covered and perfectly protected, but still visible to your customer.



CHILLING DRINKS

Due to 0% impurities, the ice is perfectly tasteless and the optimal base for your cocktail creations.



OPTIMAL ICE TEMPERATURE

The temperature of the ice is exactly 0°C cold, hence unpleasant 'freeze-burns' are prevented. The ice is completely clear, allowing the produce to be covered entirely, which helps to maintain optimal temperatures around your vulnerable and delicate foods.



THE EDGE

The most unbeaten characteristic of Hoshizaki's Crescent Ice is its unique form which allows splash-free serving of post mix soft drinks, whilst being the most economical ice, as it offers an optimal drink displacement.



NO CLUSTER

Round edges of the ice prevent clustering when keeping it in buckets for beverage cooling or in a fresh meat, fish or buffet display. Fresh produce or buffet bowls can be rearranged constantly, without any compromises on texture or taste of the produce.



USAGE AREAS



Hospitality



Catering



Healthcare



Food-processing



Marine



EVERCHECK

- Specifically developed for the Crescent Ice Makers
- Visible and audible alarm when maintenance assistance is required
- Main service and maintenance routines can be carried out through the front access
- Controls are located in a dry environment, greatly improving electrical component reliability



CYCLES AVER

- Hoshizaki's Crescent Ice Makers produces the same quantity of ice in half as many cycles
- Fewer cycles per day results in increased longevity and profits
- Reduced operating cycles by half, while producing the same quantity of ice compared to competitors

HOSHIZAKI'S SIGNATURE ICE TYPE

ABOUT THE RANGE

The double-sided evaporator in all our Crescent Ice Makers is made of stainless steel - the best material for improved longevity, food safety and damageless cleaning.

With the increased ice-to-steel surface of the improved evaporator, the Crescent Edge Ice Makers even outperforms the powerful earlier generation, when it comes to harvest cycles and production capacities. The compact parameters of the self contained models makes it a perfect fit for small spaces. Furthermore, the smart plug-and-play design guarantees the extremely easy and quick set-up.

Always focusing on operating convenience and food safety, all units (including the air filter) are easily accessible from the front. Keep in mind that frequent cleaning routines will improve the longevity of your machine.

The fully automatized, digitally controlled ice making process requires no manual adjustments and can be a true time saver for your staff.

DOUBLE PRODUCTION



The improved double evaporator with its double-sided, stainless steel surface makes the same amount of ice in half the time.

MAXIMUM HYGIENE



The compartmentalized interior of the ice maker is a smart design feature to boost the food safety, as it protects the water circuit from any outside contamination.

FLEXIBILITY



Need to amp up your production capacity? The variable setup with modular bins and bases allow the user to mix and match depending on individual requirements and conditions.

CRESCENT ICE MAKERS



Self contained

KM-40B



Production capacity/24 h:
43 kg
Bin capacity: 16 kg



Self contained

KM-55B



Production capacity/24 h:
53 kg
Bin capacity: 23 kg



Self contained

KM-80B



Production capacity/24 h:
79 kg
Bin capacity: 40 kg



Self contained

KM-140B



Production capacity/24 h:
138 kg
Bin capacity: 55 kg



Modular

KM-660MAJ-E



Production capacity/24 h:
280 kg



KM-1301SAJ-E

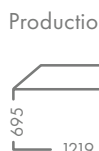

Production capacity/24 h: 624 kg

PAIRING AESTHETICS AND FUNCTIONALITY

EYE CANDY FOR YOUR DRINKS

Expand your creative horizon and your craft's aesthetic possibilities with the help of our Special Ice Makers that produce different, extraordinary shapes of ice.

Specially tailored for cocktail bars that like to differentiate themselves from others, whilst never compromising on taste and quality of their drinks. With perfect ice characteristics still in focus, you can now add a decorative highlight to your cocktails and long drinks.

Our Special Ice Makers work, similar to our famous Cubers, with our patented closed-cell system.

Each ice shape is made individually by a dedicated spray of fresh water. This happens within a closed cell to achieve the highest possible compactness of an ice cube with the perfectly precise shape of a ball, star, heart, cylinder, big cube or long cube.

Owners of a Hoshizaki Special Ice Maker can look back on times of manually molding single ice forms. Now, they enjoy the convenience of scooping absolutely identical ice shapes from the built-in and easily accessible storage container.

SPECIAL ICE

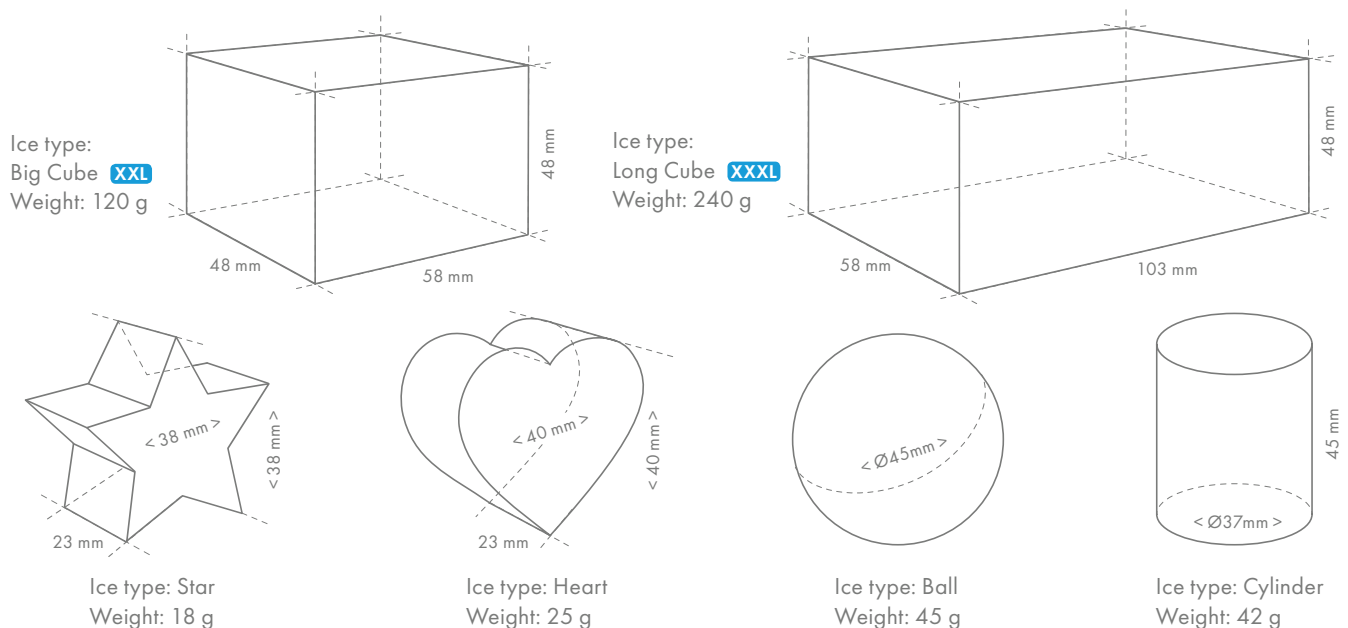

SPECIAL ICE MAKERS

Stackable



Self contained



“Hoshizaki is a market leader when it comes to ice, but more than that, they are an aspirational brand (...) creating ice in a different form, that allows you to be more creative behind the bar.”

Andrew Mullins

Operations Director
Fling Bar Services Dubai (UK/UAE)
September 2018

IM-65NE-Q BALL ICE MAKER



Production capacity/24 h:
22 kg
Bin capacity: 26 kg
Ice type: Ball

IM-240DNE-C CYLINDER ICE MAKER

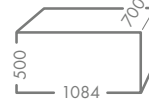

Production capacity/24 h:
240 kg
Ice type: Cylinder

USAGE AREAS



Hospitality



Catering



Education



Leisure



Marine

Big Cube



Ball Ice



Heart-shaped Ice



Star-shaped Ice



THE RAPID FRESH MAKERS

WATER & ICE – IS THERE A BETTER TEAM?

Dispensers play a crucial role when business owners want to provide ice and/or water for self-service. The three steps of quality ice production, protected ice storage and the quick service of ice are all combined in one device – with the help of only one button your refreshment is ready in seconds.

With **DCM DISPENSERS** the user can select from these options:

- Cubelet ice only
- Cubelet ice and water
- Water only

The production capacities of these compact, yet powerful ice/water dispensers range from 60 kg a day for smaller businesses to up to 230 kg a day for sizable venues, such as amusement parks, hotel resorts and large-scale quick serve environment.

Most commonly, Hoshizaki dispensers are used, where a quick, efficient, and food-safe serving of ice-water combinations is needed.

DIM DISPENSERS produce and provide the famous Hoshizaki cubes for handy self-service. What makes this dispenser so popular is its convenient portion control, which can be set easily. This allows you to precisely regulate the serving sizes. This range of self-serve dispensers is often placed in hotels, positioned on each floor, to provide guests with quality ice all around the clock.

With an elegant and lean look, they almost disappear within modern interior designs. Focusing on user-friendliness and maximum food safety, air or light never hits the freshly produced ice, while stored, providing maximum contamination protection for operators and consumers.

DSM DISPENSERS are compact and reliable appliances that produce and serve high quality shuttle ice. The simple design and smart features, for food safety and against contamination, make DSM dispensers popular for hospitals and health care institutions.

DISPENSERS ICE

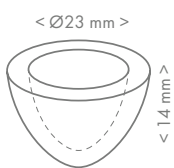

Ice type: Shuttle
Weight: 3 g

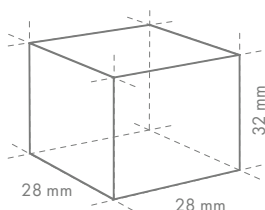

Cube Size: **L**
Weight: 23 g

USAGE AREAS



Hospitality



Catering



Healthcare



Education



Marine

ICE AND/OR WATER DISPENSERS



DSM-12DE ICE

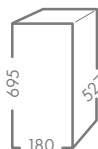

Production capacity/24 h:
13 kg
Bin capacity: 3 kg
Ice type: Shuttle



DIM-30DE-2 ICE



Production capacity/24 h:
42 kg
Bin capacity: 42 kg
Ice type: Cube **L**



DCM-120KE(EU) ICE & WATER



Production capacity/24 h:
125 kg
Bin capacity: 1.9 kg
Ice type: Cubelet & Water

EASY FIT



Our dispenser portfolio accommodates suitable appliances for different requirements regarding serving amounts, storage capacity and space limitations.

SUSTAINABLE



Waste control for more sustainability; these dispensers allow intuitive portion control. This helps to regulate the consumption of ice among end-user, reducing overall energy consumption and waste.

FOOD SAVE



As with all Hoshizaki machines, hygiene, food safety and contamination protection play a major role. Dispensers are operated by consumers directly. In order to eliminate health risks, the machines are designed to never let air or water hit the freshly produced ice, while stored.

SPECIALTY

SPECIALTIES
FROM HOSHIZAKI

HOSHIZAKI EQUIPMENT REALLY IS BUILT TO LAST!

Two Hoshizaki sushi cases are sited in prime position on the sushi bar at Matsuri, a Japanese fine dining restaurant situated in the heart of London's Mayfair.

Since the restaurant opened in 1993, Hoshizaki sushi cases have been in daily use. Manager Cristoforo Santini explains; "I believe the first sushi case we had lasted for 10 or 12 years and was replaced with one of the pair we're using now" – Hoshizaki equipment really is built to last!

*"The display cabinets
have certainly
attracted customers"*

Cristoforo Santini

Manager Japanese fine dining restaurant
Matsuri in London

A display case will generally come in two types of refrigeration: gravity coil and forced air.

With the Hoshizaki display cases you avoid the drying effect on uncovered food of forced air refrigeration. Cold air is simply 'dropped' over the food and chills it – the preferred option for salads, meat, seafood and sushi.



GOOD FOOD COMES FROM FRESH INGREDIENTS

PROUDLY DISPLAY YOUR FRESH FISH, MEAT AND PERISHABLE PRODUCTS

Our line of refrigerated display cases combine innovative features with a modern and elegant design, and are configured to highlight and preserve the freshness of even the most delicate fish types.

The range is designed to maintain the most natural level of humidity and food-safe temperatures, even during peak serving times with frequent door openings.

The smooth and diffused airflow works without any forced air circulation. This method creates ideal conditions avoiding unpleasant dehydration and weight loss of the stored goods.

SIMPLE IS SMART

One of the strikingly simple solutions for easy and fast temperature control: The inside tray can be flipped face up or face down to set the perfect inside temperature for different types of fish.

The elevated side wings of the trays allow more air circulation, lowering the storage temperature instantly.

Tray facing up: More delicate fish types.

Tray facing down: Fish types that require lower storage temperatures.

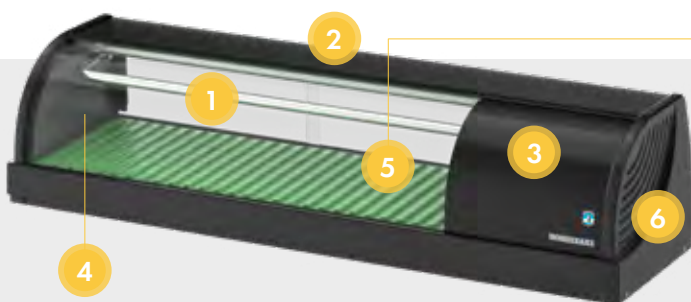

1. | Tubular-shaped evaporator absorbs the heat continuously
Condensation freezes on its external surface, maintaining an attractive frost layer with no dripping
2. | Practical anti-slip top: ideal to place serving dishes
3. | Sliding door with 150 mm height, easily disassembled and removed for daily cleaning
4. | Curved glass for optimal visibility of the displayed food
5. | Lightweight ABS trays with a wave-shaped profile, removable for easy cleaning
6. | The **condensing unit** of all our models sit either on the right- or left-hand side, with the outflow of air positioned on the sides away from the operator

SPECIALTIES

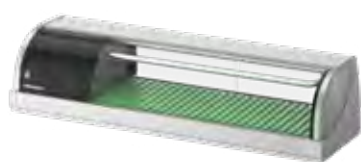

HNC-120BE

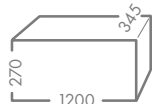

Net capacity: 42 litres
Average temperature: 3°C



HNC-150BE

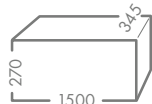

Net capacity: 57 litres
Average temperature: 3°C



HNC-180BE

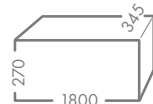

Net capacity: 72 litres
Average temperature: 3°C

Refrigerated display cases are also available with 2100 mm width



All models are available in either black or steel finish, and with the choice of having the condensing unit on the right- or left-hand side.

For all models: Electrical supply: 1/220 -240/50Hz - Electrical consumption 0.15 (kW)

COOKING EACH RICE GRAIN TO PERFECTION

TIGER This automatic rice-cooker produces up to 40 cups of rice, with the ability to keep the rice warm for 12 hours. Additionally, the thermal warmers are able to preserve the rice up to 6 hours at serving temperature without using any electricity, while preserving its just-cooked texture.



JNO-B36W RICE COOKER



Cooking capacity: 3.6 l

* incl. handles
Height, lid opened: 72 cm



JFM-390P/570P THERMAL HEATING



Capacity: 3.9 / 5.7 l

* incl. handles



LEADING NATURALLY

OUR BRANCH OFFICES

HOSHIZAKI EUROPE B.V. - HQ

Burgemeester Stramanweg 101
1101AA Amsterdam
Noord-Holland
The Netherlands
T. +31 (0)20 6918499
E. sales@hoshizaki.nl

UK OFFICE

2 The Technology Centre
London Road
Swanley, Kent BR8 7AG
United Kingdom
T. +44 (0)845 456 0585
E. uksales@hoshizaki.uk

BUREAU FRANÇAIS

Paris Nord II, 13 Rue De La Perdrix
BP 44072 Tremblay En France
95913 Roissy Charles De Gaulle Cedex
France
T. +33 (0)1 48 63 93 80
E. info@hoshizaki.fr

BÜRO DEUTSCHLAND

Kampstrasse 16
D-31180 Giesen-Hasede
Deutschland
T. +49 (0)5121 697370
E. vertrieb@hoshizaki.de

BÜRO DEUTSCHLAND

Halskestrasse 17
47877 Willich-Munchheide III
Deutschland
T. +49 (0)2154 92810
E. vertrieb@hoshizaki.de

BENELUX OFFICE

Twentepoort West 62
7609 RD Almelo
Nederland
T. +31 (0)85 0188370
E. info@hoshizaki.nl

OFICINA DE IBERIA (ESPAÑA & PORTUGAL)

Edificio Roma, módulo C, Planta 2ª
Ctra. de l'Hospitalet 147-149
08940 Cornellá de Llobregat
Barcelona – Spain
T. +34 (0)93 478 09 52
E. info@hoshizaki.es

MIDDLE EAST OFFICE

Lob 16 – 308
PO Box 261761
Jebel Ali Free Zone
Dubai, United Arab Emirates
T. +971 (0)48 876 612
E. sales@hoshizaki.ae

HOSHIZAKI - EXPORT

Burgemeester Stramanweg 101
1101AA Amsterdam
Noord-Holland
The Netherlands
T. +31 (0)20 6918499
E. sales@hoshizaki.nl

SALG DANMARK

Aage Grams Vej 1
6500 Vojens
Danmark
T. +45 8988 5350
E. info@hoshizaki.dk

SALG NORGE

Pb. 2126
3103 Tønsberg
Norge
T. +47 8150 3434
E. infoNO@hoshizaki.dk

FÖRSÄLJNING SVERIGE

Box 5157
200 71 Malmö
Sverige
T. +46 108 84 87 47
E. orderSE@hoshizaki.dk

FILIALE ITALIANA

P.za S.Maria Beltrade 1
20123 Milano
Italia
T. +39 348 302 2156
T. +39 344 061 6467
E. info@hoshizaki.it



HOSHIZAKI | **GRAM**

BUILT ON STRONG FOUNDATIONS

Hoshizaki has earned an international reputation for pioneering innovation in kitchen and food service equipment solutions. By merging with refrigeration specialist Gram Commercial, we have brought together the brilliance of Japanese engineering and the intelligence of Danish design. Our collaboration has created the world's most connected, innovative and responsible manufacturer of cold solutions.

Together, we continue to explore the realms of possibility.

Hoshizaki UK

2 The Technology Centre
London Road
Swanley, Kent BR8 7AG
United Kingdom
T. +44 (0)845 456 0585

uksales@hoshizaki.uk
www.hoshizaki-europe.com



Every effort has been made to ensure that the information contained in this publication is accurate at the time of publishing. Hoshizaki Europe B.V. assumes no responsibility or liability for typographical errors or omissions or for any misinterpretation of the information within the publication and reserves the right to change without notice.