

Prodis

issue 1



product
portfolio

www.prodis.co.uk

Contact Us

Project Distribution Ltd
Unit 1 Sun Street
Stoke on Trent
Staffordshire
ST1 4JW

Tel: 01782 280289
www.prodis.co.uk
sales@prodis.co.uk

Warranty Guide



Units are supplied with a 1 year parts only warranty as standard.

Labour warranty can be added at an additional cost.

Warranty commences from date of invoice.



Units are supplied with a 2 year parts only warranty as standard.

Labour warranty can be added at an additional cost.

Warranty commences from date of invoice.



Units are supplied with a 2 year on site parts and labour warranty as standard

Warranty commences from date of invoice.



Units are supplied with a 5 year on site parts and labour warranty as standard.

Warranty commences from date of invoice.

Delivery Guide



The majority of products listed in this catalogue ship on a 2-3 working day, kerbside delivery.

Overnight deliveries are available on key items.

Some larger items including serve over counters and multideck display cases will ship on a 3-5 working day delivery

Delivery service upgrades are available including

Position & unpack

Uplift and disposal of an old cabinet at the same time as delivery

AM, PM and timed delivery services

Please refer to the back cover of the catalogue for prices for these services

SPECIAL ORDER

Items marked as special order carry a longer lead time, please call our sales team for delivery information on these products.



BOTTLE COOLERS	2-7
WINE COOLERS	8
BOTTLE DUMPS	9
GLASS FROSTERS	10
BEER DISPENSERS	11
SELF CONTAINED ICE CUBE MAKERS	14-21
NUGGET ICE MAKERS	22-23
MODULAR ICE CUBE MAKERS	17, 24-25
ICE FLAKERS	26-27
ICE STORAGE SILOS & CARTS	28-30
ICE DISPENSERS	31
ICE CRUSHERS	33
UPRIGHT DISPLAY FRIDGES & FREEZERS	36-42
DISPLAY CHEST FREEZERS	43
MULTIDECK DISPLAY CASES	44-48
SERVE OVER COUNTERS	49-55
FRESH FISH DISPLAYS	56-57
PATISSERIE COUNTERS	58-61
BESPOKE COUNTER SOLUTIONS	62-68
STORAGE REFRIGERATION	70-73
UPRIGHT SERVICE REFRIGERATION	74-79
GASTRONORM COUNTER REFRIGERATION	80-83
COMPACT COUNTER REFRIGERATION	84-85
SALAD & FOOD PREPARATION COUNTERS	86-91
PIZZA PREP COUNTERS	92-93
CHEF BASES	94
TOPPING UNITS	95
CHEST FREEZERS	96-97
BLAST CHILLERS	98-101
COLDROOMS	102-104
VINYL WRAPPED GLASSWASHERS	106-107
GLASS WASHERS	108-113
CABINET DISHWASHERS	114-115
HOOD DISHWASHERS	116-119
POT WASHERS	120-121
RACK CONVEYOR DISHWASHERS	122-125
ACCESSORIES	126
ELECTRIC FRYERS	128
GRIDDLES	129
CONTACT GRILLS	129
ADJUSTABLE SALAMANDER GRILL	130
CREPE STATION	130
PIE CABINETS	131
SOUP STATIONS	131
CONVECTION OVENS	132
TERMS AND CONDITIONS	139-140
DELIVERY & INSTALLATION	141

Section Index

Bar Refrigeration

Page 1 - 12

BOTTLE COOLERS
BOTTLE DUMPS
GLASS FROSTERS
WINE COOLERS
BEER DISPENSERS

Ice Machines

Page 13 - 34

SELF CONTAINED ICE MAKERS
MODULAR ICE MAKERS
NUGGET ICE MAKERS
ICE FLAKERS
STORAGE BINS
ICE DISPENSERS
ICE CRUSHERS

Display Refrigeration

Page 35 - 68

GLASS DOOR COOLERS
GLASS DOOR FREEZERS
DISPLAY CHEST FREEZERS
MULTIDECK DISPLAYS
SERVE OVER COUNTERS
FRESH FISH DISPLAYS
PATISSERIE COUNTERS

Storage Refrigeration

Page 69 - 104

UNDERCOUNTER REFRIGERATION
UPRIGHT REFRIGERATION
COUNTER REFRIGERATION
SALADETTE AND PREP COUNTERS
CHEF BASES
CHEST FREEZERS
BLAST CHILLERS
COLDROOMS

Warewashing

Page 105 - 126

GLASSWASHERS
CABINET DISHWASHERS
HOOD DISHWASHERS
POT WASHERS
ACCESSORIES

Catering Equipment

Page 127 - 132

FRYERS
GRIDDLES
CONTACT GRILLS
SALAMANDER GRILLS
SOUP STATIONS
PIE CABINETS
CONVECTION OVENS

QUICK REFERENCE

Model	List	Pg	Model	List	Pg	Model	List	Pg	Model	List	Pg	Model	List	Pg
PRODIS			CL20	£520	15	FGR24	£460	129	JET35E	£1,060	113	NTGFC	£1,500	10
A10C	£2,420	53	CL40	£1,000	16	FGR36	£700	129	JET35P	£1,380	113	PS135	£4,255	21
A10F	£2,300	51	CL60	£1,200	16	FSK15	£2,270	57	JET40	£1,260	113	PS180M	£4,615	21
A15C	£2,700	53	CL90	£1,600	16	FSK15C	£2,800	57	JET40P	£1,520	113	PS25	£1,350	21
A15F	£2,650	51	CL210M	£3,000	17	FSK20	£2,500	57	JET50	£1,740	113	PS35	£1,630	21
A20C	£3,500	53	CMII-10	£3,860	48	FSK20C	£3,000	57	JET50D	£1,910	114	PS40	£1,945	21
A20F	£3,300	51	CMII-12	£4,210	48	FSK25	£2,800	57	JET50DP	£2,100	114	PS55	£2,100	21
A25C	£3,850	53	CMII-20	£5,380	48	FSK25C	£3,200	57	JET50P	£1,930	113	PS75	£2,410	21
A25F	£3,550	51	CMII-24	£6,250	48	FSK30	£3,170	57	JV100	£4,150	55	S100	£4,550	120
A60/100	£3,900	45	CR3	£1,500	33	FSK30C	£3,400	57	JV125	£4,500	55	S180	£1,525	29
A60/100-FV	£3,950	47	CR5	£2,635	33	FPC20	£340	130	JV150	£4,800	55	S200	£10,800	120
A60/125	£4,100	45	CT120	£10,600	121	FPC60	£410	130	JV200	£5,850	55	S230	£1,650	29
A60/125-FV	£4,200	47	CT200	£17,000	123	FSS4	£410	130	JV245	£6,450	55	S340	£2,195	29
A60/150	£4,550	45	E35	£1,330	111	GR1125	£11,330	27	JVE45	£4,300	55	S350	£16,000	121
A60/150-FV	£4,650	47	E40	£1,470	111	GR135	£3,955	27	JVE90	£5,850	55	S390	£2,310	29
A60/200	£5,100	45	E40P	£1,780	111	GR140	£3,730	27	JVI45	£4,550	55	S480	£2,670	29
A60/200-FV	£5,200	47	E80X	£2,140	111	GR220	£4,090	27	JVI90	£6,350	55	S6C	£350	14
A80/100	£4,000	45	E80XP	£2,330	111	GR390	£5,060	27	M100	£2,500	49	SC140	£5,060	30
A80/100-FV	£4,050	47	EC-2PREP	£1,140	86	GR565	£5,860	27	M150	£2,900	49	SC300	£6,975	30
A80/125	£4,200	45	EC-2SALAD	£860	87	GRN-1F	£1,780	75	M200	£3,600	49	SCD400	£9,775	30
A80/125-FV	£4,250	47	EC-2SS	£980	85	GRN-1R	£1,500	75	M250	£3,900	49	SCD600	£11,640	30
A80/150	£4,650	45	EC-3PIZZA	£1,900	93	GRN-2F	£2,710	75	M300	£4,530	49	SCD830	£12,770	30
A80/150-FV	£4,700	47	EC-3PREP	£1,560	86	GRN-2R	£2,510	75	MX3.10C	£3,190	101	SD100	£4,470	31
A80/200	£5,200	45	EC-3SALAD	£1,140	87	GRN-C2F	£1,640	81	MX5.12C	£3,760	101	SD100W	£4,560	31
A80/200-FV	£5,250	47	EC-3SS	£1,170	85	GRN-C2R	£1,350	81	MX5.12ST	£3,900	101	SD60	£4,370	31
AR350SS	£680	97	EC-4DSS	£1,480	85	GRN-C3F	£1,860	81	MXT10.35	£6,960	101	SD60W	£4,470	31
AR350W	£590	97	EC-6DSS	£2,210	85	GRN-C3R	£1,550	81	MXT14.40	£8,530	101	T1115	£3,390	116
AR450SS	£800	97	EC-T12G	£700	95	GRN-W2F	£1,660	81	MXT5.15	£4,730	101	T1115BT	£3,680	116
AR450W	£690	97	EC-T12S	£630	95	GRN-W2R	£1,370	81	MXT5.20	£4,980	101	T1215	£3,800	117
AR550SS	£990	97	EC-T15G	£780	95	GRN-W3F	£1,880	81	MXT5.30	£5,550	101	T1215BT	£4,090	117
AR550W	£820	97	EC-T15S	£700	95	GRN-W3R	£1,570	81	MXT7.20	£5,730	101	T1515	£5,090	118
AR650SS	£1,140	97	EC-T18G	£850	95	GV1	£690	43	MXT7.30	£6,030	101	T1515BT	£5,400	118
AR650W	£970	97	EC-T18S	£760	95	GV2	£750	43	N300	£6,330	23	T1515BTHR	£9,680	119
C135	£2,635	19	EV35	£1,490	109	GV3	£850	43	NT10-HC	£970	7	XD1201	£1,460	40
C220M	£3,315	25	EV35G	£1,330	109	GV4	£950	43	NT10ST-HC	£1,080	6	XD260C	£590	38
C25	£970	19	EV40	£1,700	109	HC201F	£620	71	NT1BH-HC	£500	2	XD2NW	£2,480	37
C300M	£4,655	25	EV40G	£1,470	109	HC201FSS	£680	71	NT1BHLO-HC	£520	2	XD2PW	£1,540	37
C35	£1,280	19	EV40S	£2,140	109	HC201G	£640	41	NT1BHSP-HC	£520	2	XD380	£660	39
C405M	£4,355	25	EV50	£2,260	109	HC201R	£570	71	NT1SLIM-HC	£480	2	XD701	£1,190	40
C45	£1,420	19	EV50G	£2,140	109	HC201RSS	£640	71	NT1ST-HC	£570	5	XW380	£910	8
C60	£1,700	19	EV50S	£2,750	109	HC401F	£870	72	NT20-HC	£1,280	7			
C80	£2,225	19	EV80	£2,590	115	HC401FSS	£960	72	NT20ST-HC	£1,440	6			
CAL10A	£2,900	61	F10A	£2,900	59	HC401G	£930	41	NT2BH-HC	£600	3	TRUEMFG		
CAL10AO	£3,260	61	F10R	£4,500	59	HC401R	£800	72	NT2BHLO-HC	£620	3	TDD Series	11	
CAL10H	£3,550	61	F14A	£3,400	59	HC401RSS	£880	72	NT2BS-HC	£600	3	TBB Series	12	
CAL10HO	£3,260	61	F14R	£5,200	59	HC601F	£1,060	73	NT2BSLO-HC	£640	3	GDM Series	42	
CAL10R	£4,450	61	FAS23	£530	130	HC601FSS	£1,170	73	NT2ST-HC	£670	5	TGN Series	76	
CAL10RO	£4,550	61	FCG1	£380	129	HC601R	£990	73	NT3BH-HC	£800	4	T Series	77-79	
CAL14A	£3,450	61	FCS1	£1,090	130	HC601RSS	£1,100	73	NT3BS-HC	£800	4	TC Series	83	
CAL14C	£5,050	61	FDf106	£430	128	HS43	£1,155	132	NT3ST-HC	£870	5	TSSU Series	88-90	
CAL14H	£4,350	61	FDf206	£710	128	HS43GH	£1,360	132	NTBD1	£880	9	TFP Series	91	
CAL14R	£5,050	61	FDf7	£206	128	HS46H	£1,950	132	NTBD2	£1,040	9	TPP Series	92	
CD90	£3,010	22	FDf77	£316	128	JET35	£1,110	113	NTBD3	£1,310	9	TRCB Series	94	

THE ALL NEW NT SERIES RAISING THE BAR ONCE AGAIN

NEW



Our entire NT series has been redesigned and refreshed for 2020.

Building on the success of our best selling NT series and listening carefully to customer feedback, we have updated and redesigned some of the key features of this range.

These changes will increase reliability whilst reducing energy consumption and running costs across the entire range.

To emphasise the value for money and reliability the NT series now represents we have increased the warranty on the entire range to 2 years parts & labour*.

Delivering even more value for money and raising the bar in the bottle cooler market once again.

SEE PAGES 2-7



HYDROCARBON
REFRIGERANT
COLDER BY NATURE

powered by
embraco



*Applies to cabinets sold after 9th January 2020

N300 HIGH VOLUME NUGGET ICE MAKER

The N300 is ideal for nightclubs and cocktail bars that require a high volume of nugget ice for cocktails.

The ice maker produces 310kg of nugget ice per day and is designed to be used in conjunction with the slim line S180 storage silo allowing for installation in tight spaces.

SEE PAGE 23



NEW

C300M SLIMLINE MODULAR ICE MAKER

The new slim line C300M modular ice maker has been designed with a compact 559mm wide foot print to allow for installation in the smallest of spaces.

Producing 300kg of dice shaped ice cubes per day and designed to be installed on the new slim line S180, 180kg storage bin.

SEE PAGE 25



NEW

THE NEW CL40 - 45KG ICE MAKER



NEW

The CL40 is ideal for pubs, small clubs, cafes, bars and restaurants. The ice machine produces 45kg of 'dice' shaped ice per day and has a generous 13kg storage bin.

Maintenance is easy thanks to the simple to use cleaning cycle and removable condenser air filter.

Electronic controls with LED indicators allow for easy operation.

Due Spring 2020

SEE PAGE 16

THE NEW CL60 - 62KG ICE MAKER



NEW

The CL60 is ideal for pubs, small clubs, cafes, bars and restaurants. The ice machine produces 62kg of 'dice' shaped ice per day and has a generous 22kg storage bin.

Maintenance is easy thanks to the simple to use cleaning cycle and removable condenser air filter.

Electronic controls with LED indicators allow for easy operation.

Due Spring 2020

SEE PAGE 16

THE NEW CL90 - 102KG ICE MAKER



NEW

The CL90 is ideal for pubs, clubs, cafes, bars and restaurants. The ice machine produces 102kg of 'dice' shaped ice per day and has a generous 32kg storage bin.

Maintenance is easy thanks to the simple to use cleaning cycle and removable condenser air filter.

Electronic controls with LED indicators allow for easy operation.

Due Spring 2020

SEE PAGE 16

THE NEW CL210M - 208KG MODULAR ICE MAKER



NEW

The new CL210M is perfect for night clubs, fast food establishments, bars and restaurants that require a large volume of ice at all times.

The CL210M is capable of producing 210kg of ice per day and is supplied as standard with a 180kg storage bin.

Due Spring 2020

SEE PAGE 17

**XD260C
COMPACT DISPLAY FRIDGE**



NEW

New for 2020, the XD260C is a compact display cooler designed for places where space is at a premium.

The XD260C features 4 adjustable shelves with ticket strips, a self closing, lockable door, LED lighting and illuminated merchandising canopy.

SEE PAGE 38

**XD701
DOUBLE DOOR DISPLAY FRIDGE**



NEW

Featuring an all white interior and exterior the neutral appearance of the XD701 will compliment the design of any store.

A 600mm deep footprint allows for easy installation in the tightest of spaces.

Available with optional XDGLIDE shelving

SEE PAGE 40

**XD1201
HIGH CAPACITY DISPLAY FRIDGE**



NEW

Featuring an all white interior and exterior the neutral appearance of the XD1201 will compliment the design of any store.

Maximum display space in a high capacity cooler with a massive 1250 litre capacity.

Available with optional XDGLIDE shelving

SEE PAGE 40

XD GLIDE GRAVITY FEED SHELVING SYSTEM

SEE PAGE 40



Introducing XD-GLIDE, our revolutionary new gravity feed shelving system, available for the XD701 & XD1201.

Specifically designed for busy retail environments, XD GLIDE is the fastest, most flexible shelving system on the market.

Adjustable guide rails can accommodate 330ml cans, 500ml PET bottles and many more common retail pack sizes.

The inclined shelf is fitted with rollers to ensure product is always on display and in easy reach for the customer.

NEW

FISK FRESH FISH DISPLAY NEW SIZES AND REFRIGERATED DECKS

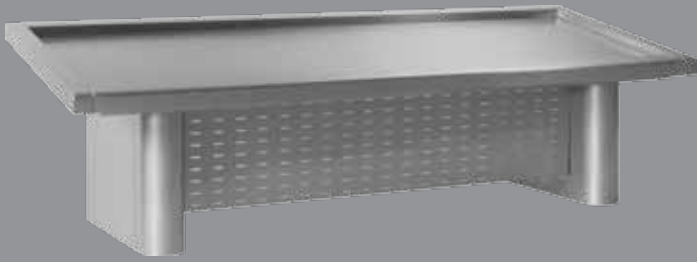

Our popular range of fresh fish displays has been extended, adding 2m and 2.5m decks to the existing 1.5m and 3m decks.

All sizes are also as either ambient or refrigerated decks, both designed to be used in conjunction with flaked ice.

The counters can be multiplexed together to create a seamless counter run and all are available with optional scale supports and acrylic fronts.

NEW

SEE PAGE 57



HC SERIES REFRESHED FOR 2020

The best selling HC series has had a refresh and redesign for 2020.

Available in 200, 400 & 600 litre cabinets finished in white or stainless steel the HC series is as comprehensive as ever but now features R290 in the freezer cabinets for better temperature regulation and faster temperature pull down.



NEW

SEE PAGE 70



MX SERIES BLAST CHILLERS - DESIGNED BY SINCOLD



SEE PAGE 98

We are pleased to announce the launch of our new MX range of blast chillers bringing the Sincold name back to the UK market.

Manufactured in Italy the Sincold MX series is solid, reliable and simple to operate and is available in a full range of sizes and capacities to suit any application.

The MX range is fitted with anti-corrosion cataphoresis coated evaporators for longevity and high reliability.

The cabinets are constructed entirely from AISI304 18/10 stainless steel for ultimate durability in even the most demanding commercial kitchen.

A rounded interior, curved base and removable tray racks allow for quick and easy cleaning.

Soft and hard cycles can be selected for both blast chilling and deep freezing, for perfect results for everything from a delicate sauce to a full roast.

A core temperature probe is fitted as standard to all models for precision temperature control.

All models within the MX range are 1/1 gastronorm compatible, smaller models can also accommodate 2/3 gastronorm whilst larger models can also take EN 60 x 40 trays.

NEW

EV SERIES GLASS AND DISHWASHERS - JOIN THE REVOLUTION



NEW

EV A new range of glass washers by Prodis. Designed from the ground up to be user friendly, energy efficient, intelligent and hygienic.

The bright LED display can easily be read in low light situations allowing easy operation in pubs, clubs and bars.

User friendly, intuitive and informative. The large LED control panel features a bright colour coded display with easy to read illuminated buttons. This allows for easy operation and makes staff training effortless due to its simplicity.

Combining years of research and development the **EV-CLEAN** delivers the perfect result every time. The **EV** wash tank is designed without any obstruction to allow for effortless cleaning. Filters, rack guides and wash arms are ergonomically profiled to allow for easy access and removal. The innovative system automatically cleans the wash tank whenever the unit is switched off making sure your **EV** is ready for use the next day with minimal effort.

Our advanced **EV-FILTER** technology has been developed to keep both small and large dirt particles out of the wash system, delivering excellent results while keeping the components clean.

EV-LOGIC is our self diagnostic system which monitors the machines performance at all times and displays user friendly error codes which speed up troubleshooting greatly reducing the amount of downtime in the unlikely event of a breakdown.

SEE PAGE 108

JET SERIES - REDESIGNED AND UPDATED FOR 2020



NEW

The design and branding of the ever popular JET series has been refreshed to bring it up to date for 2020.



Due Spring 2020

SEE PAGE 112

CT SERIES RACK CONVEYOR DISHWASHERS



New for 2020 the CT series rack conveyor dishwashers.

Available in two sizes to meet the demands of even the busiest kitchen they are capable of washing up to 200 racks per hour.

Double skinned construction as standard guarantees quiet and cooler operation creating a more pleasant working environment.

Full width doors allow for easy and safe access to the machine and the simple and clear electronic controls make operating the CT series easy for the end user.

SEE PAGE 122

NEW

BAR REFRIGERATION



TRUE
REFRIGERATION®
Prodis

BOTTLE COOLERS
BOTTLE DUMPS
GLASS FROSTERS
KEG COOLERS
WINE COOLERS



NT-SERIES BOTTLE COOLERS

FAN ASSISTED COOLING

AUTOMATIC DEFROST

DIGITAL CONTROL

LED ILLUMINATION

LOCKABLE DOOR

SELF CLOSING DOOR

LOW PROFILE OPTION

LEFT HAND OPTION

INCREASED STORAGE



Standard Features

- +2°C to +10°C temperature range
- Black exterior finish
- White easy to clean interior
- Plastic coated non-slip shelving system
- 2 x adjustable shelves
- Energy efficient pure white LED lighting
- Covered and recessed digital temperature controller
- ECO friendly R600a hydrocarbon refrigeration system
- Fan assisted cooling
- Lockable, self closing doors

Optional Features

- Scalloped wine shelves

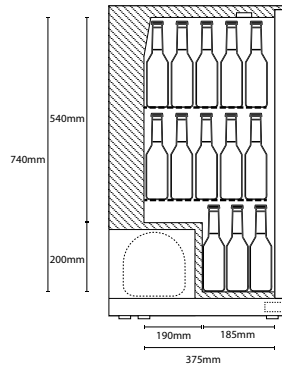

Optional wine shelf

powered by*
embraco

R600a



HYDROCARBON
REFRIGERANT
COLDER BY NATURE

MODEL	DOORS	CAPACITY	WIDTH	DEPTH	HEIGHT	LIST PRICE
NT1SLIM-HC	1 Hinged	105 Litres	500	520	900	£480
NT1BH-HC	1 Hinged	126 Litres	600	520	900	£500
NT1BHSP-HC	1 Left Hand Hinged	126 Litres	600	520	900	£520
NT1BHLO-HC	1 Hinged	119 Litres	600	520	850	£520
OPTIONS						
NTSHELF13	Chrome scalloped wine shelf (6 bottle capacity NT1BH-HC)					£30
NTSHELF14	Chrome scalloped wine shelf (5 bottle capacity NT1SLIM)					£30



NT-SERIES BOTTLE COOLERS

FAN ASSISTED COOLING

AUTOMATIC DEFROST

DIGITAL CONTROL

LED ILLUMINATION

LOCKABLE DOOR

SELF CLOSING DOOR

LOW PROFILE OPTION

INCREASED STORAGE



Standard Features

- +2°C to +10°C temperature range
- Black exterior finish
- White easy to clean interior
- Plastic coated non-slip shelving system
- 2 x adjustable shelves per door
- Energy efficient pure white LED lighting
- Covered and recessed digital temperature controller
- ECO friendly R600a hydrocarbon refrigeration system
- Fan assisted cooling
- Lockable, self closing doors

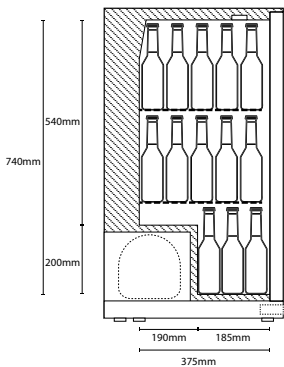

7 PERCENT
CAPACITY INCREASE
OVER PREVIOUS MODEL

2 YEAR
PARTS & LABOUR WARRANTY



MODEL	DOORS	CAPACITY	WIDTH	DEPTH	HEIGHT	LIST PRICE
NT2BH-HC	2 Hinged	220 Litres	900	520	900	£600
NT2BHLO-HC	2 Hinged	208 Litres	900	520	850	£620
NT2BS-HC	2 Sliding	220 Litres	900	520	900	£600
NT2BSLO-HC	2 Sliding	208 Litres	900	520	850	£640

powered by
embraco





NT-SERIES BOTTLE COOLERS

FAN ASSISTED COOLING

AUTOMATIC DEFROST

DIGITAL CONTROL

LED ILLUMINATION

LOCKABLE DOOR

SELF CLOSING DOOR

INCREASED STORAGE

Standard Features

- +2°C to +10°C temperature range
- Black exterior finish
- White easy to clean interior
- Plastic coated non-slip shelving system
- 2 x adjustable shelves per door
- Energy efficient pure white LED lighting
- Covered and recessed digital temperature controller
- ECO friendly R600a hydrocarbon refrigeration system
- Fan assisted cooling
- Lockable, self closing doors

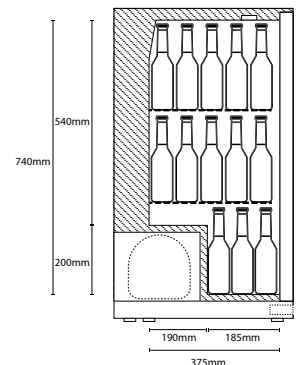

powered by
embraco

R600a



HYDROCARBON
REFRIGERANT
COLDER BY NATURE



MODEL	DOORS	CAPACITY	WIDTH	DEPTH	HEIGHT	LIST PRICE
NT3BH-HC	3 Hinged	300 Litres	1350	520	900	£800
NT3BS-HC	3 Sliding	300 Litres	1350	520	900	£800



NT-SERIES BOTTLE COOLERS

FAN ASSISTED COOLING

AUTOMATIC DEFROST

DIGITAL CONTROL

LED ILLUMINATION

LOCKABLE DOOR

SELF CLOSING DOOR

INCREASED STORAGE

2
YEAR
PARTS
&
LABOUR
WARRANTY

2
YEAR
PARTS
&
LABOUR
WARRANTY

2
YEAR
PARTS
&
LABOUR
WARRANTY



Standard Features

- +2°C to +10°C temperature range
- Stainless steel exterior and interior
- Hinged doors
- Energy efficient pure white LED lighting
- Fully adjustable chrome shelves
- 2 shelves per section
- Mirror finish stainless interior
- Lockable doors
- Self closing doors
- External light switch
- External digital temperature control

Optional Features

- Scalloped wine shelves

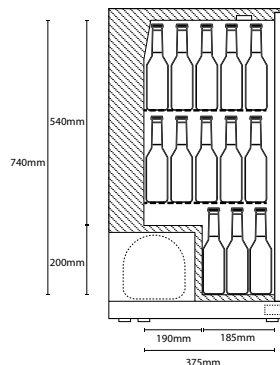

MODEL	DOORS	CAPACITY	WIDTH	DEPTH	HEIGHT	LIST PRICE
NT1ST-HC	1 Hinged	126 Litres	600	520	900	£570
NT2ST-HC	2 Hinged	220 Litres	900	520	900	£670
NT3ST-HC	3 Hinged	300 Litres	1350	520	900	£870
OPTIONS						
NTSHELF13	Chrome scalloped wine shelf (6 bottle capacity for NT1ST-HC)					£30

powered by
embraco

R600a



HYDROCARBON
REFRIGERANT
COLDER BY NATURE



NT-SERIES BOTTLE COOLERS

- FORCED AIR
- AUTOMATIC DEFROST
- DIGITAL CONTROL
- LED ILLUMINATION
- LOCKABLE DOOR
- SELF CLOSING DOOR

- -1°C to +10°C temperature range
- Mirror finish stainless steel interior
- 5 adjustable chrome shelves per door
- Pure white LED lighting
- Twin vertical LED lighting
- Lockable door
- Digital temperature control
- External light switch
- Forced air cooling
- Automatic defrost

Optional Features

- Scalloped wine shelves



MODEL	COLOUR	DOORS	CAPACITY	WIDTH	DEPTH	HEIGHT	LIST PRICE
NT10ST-HC	Stainless	1 Hinged	340 Litres	600	515	1800	£1080
NT20ST-HC	Stainless	2 Hinged	560 Litres	900	515	1800	£1440
OPTIONS							
NTSHELF13			Chrome scalloped wine shelf (6 bottle capacity)				£30
NTSHELF14			Chrome scalloped wine shelf (5 bottle capacity)				£30

NT-SERIES BOTTLE COOLERS

FORCED AIR

AUTOMATIC DEFROST

DIGITAL CONTROL

LED ILLUMINATION

LOCKABLE DOOR

SELF CLOSING DOOR



2
YEAR
PARTS
&
LABOUR
WARRANTY

Standard Features

- -1°C to +10°C temperature range
- Mirror finish stainless steel interior
- 5 adjustable chrome shelves per door
- Pure white LED lighting
- Twin vertical LED lighting
- Lockable door
- Digital temperature control
- External light switch
- Forced air cooling
- Automatic defrost

Optional Features

- Scalloped wine shelves



MODEL	COLOUR	DOORS	CAPACITY	WIDTH	DEPTH	HEIGHT	LIST PRICE
NT10-HC	Black	1 Hinged	340 Litres	600	515	1800	£970
NT20-HC	Black	2 Hinged	560 Litres	900	515	1800	£1280
OPTIONS							
NTSHELF13			Chrome scalloped wine shelf (6 bottle capacity)				£30
NTSHELF14			Chrome scalloped wine shelf (5 bottle capacity)				£30





XW-SERIES WINE CABINET

FAN ASSISTED COOLING

AUTOMATIC DEFROST

INTERIOR LIGHTING

Standard Features

- +2°C to +10°C temp. range
- Fan assisted cooling
- Adjustable thermostat
- Black powder coated exterior
- Black food safe plastic interior
- Vertical Internal illumination
- 5 scalloped wire wine shelves
- 2 inclined wire wine shelves
- 2 adjustable feet at front
- 2 rollers to rear for easy movement
- Double glazed safety glass

Optional Features

- Wooden wine shelves



2
YEAR
PARTS
ONLY
WARRANTY



MODEL	CAPACITY	SHELVES	CLOUR	WIDTH	DEPTH	HEIGHT	LIST PRICE
XW380	372 Litres	7	Black	595	650	1860	£910
XWWSH			Optional Wooden Wine Shelf				£70

NT-SERIES BOTTLE DUMPS

FORCED AIR

AUTOMATIC DEFROST

DIGITAL CONTROL

LOCKABLE LIDS

2
YEAR
PARTS
&
LABOUR
WARRANTY



NTBD1



NTBD2



NTBD3



Standard Features

- +2°C to +8°C temperature range
- Durable black exterior finish
- Sliding tops for easy access
- Aluminium interior
- Hard wearing stainless steel tops
- Adjustable bin dividers included
- Bottle opener and cap catcher fitted
- Digital temperature control
- Digital temperature display
- Mains on/off switch
- Static cooling
- High density polyurethane insulation

MODEL	COLOUR	LIDS	CAPACITY	WIDTH	DEPTH	HEIGHT	LIST PRICE
NTBD1	Black	1	279 Litres	935	687	888	£880
NTBD2	Black	2	417 Litres	1255	687	888	£1040
NTBD3	Black	2	577 Litres	1634	687	888	£1310



FORCED AIR

AUTOMATIC DEFROST

DIGITAL CONTROL

LED ILLUMINATION

SELF CLOSING DOOR



Standard Features

- Stainless steel exterior
- Stainless steel interior
- Forced air refrigeration
- Frost free operation
- Automatic defrost
- Frosted glasses in minutes
- Also suitable for keeping spirits at ice cold temperatures
- Heated glass door to prevent condensation build up
- -10°C to -15°C temperature range
- 2 fully adjustable shelves



R290



HYDROCARBON
REFRIGERANT
COLDER BY NATURE

MODEL	COLOUR	DOORS	CAPACITY	WIDTH	DEPTH	HEIGHT	LIST PRICE
NTGFC	Stainless	1 Glass	100 Litres	595	525	875	£1500

NITRO
TRUE
COLD BREW
 SOLID SWING DOOR
 DIRECT DRAW
 DISPENSER
COFFEE



True
 REFRIGERATION

TDD-SERIES

BEER DISPENSERS

WARRANTY 5 YEARS
 PARTS, COMPRESSOR AND LABOUR

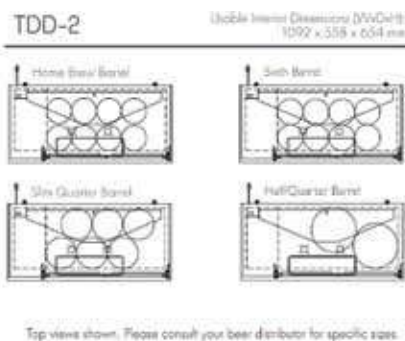
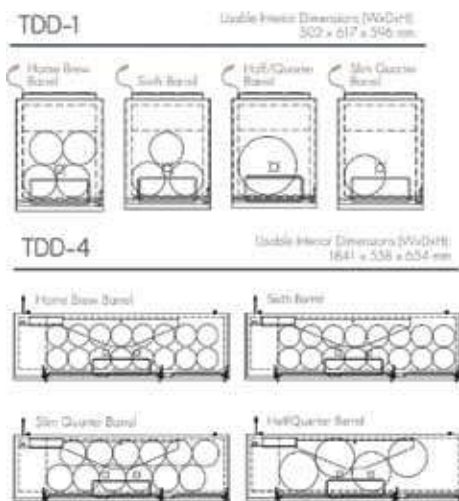

Standard Features

- Provides ice cold beer 0.5°C to 3.3°C
- Heavy duty vinyl or stainless steel exterior finishes
- Stainless steel interior floor
- 77mm diameter stainless steel insulated beer column
- Cold air is directed into the beer column to prevent foaming
- Castors fitted to TDD-1 & TDD-1-S
- Accommodates a variety of beer kegs
- Positive seal doors

Optional Features

- Nitro cold brew coffee kit

S - Stainless Steel
 CT - Club Top

MODEL	COLOUR	BARRELS	DOORS	WIDTH	DEPTH	HEIGHT*
TDD-1	Black	1	1	597	794	1010
TDD-1-S	Stainless	1	1	597	794	1010
TDD-2	Black	2	2	1496	689	940
TDD-2-S	Stainless	2	2	1496	689	940
TDD-2CT	Black	2	2	1496	689	978
TDD-2CT-S	Stainless	2	2	1496	689	978
TDD-4	Black	4	3	2296	689	940
TDD-4-S	Stainless	4	3	2296	689	940
TDD-4CT	Black	4	3	2296	689	978
TDD-4CT-S	Stainless	4	3	2296	689	978

*+362mm for draft column

True
REFRIGERATION
TBB-SERIES
BACK BARS



Standard Features

- 0.5°C - 3.3°C temperature range
- Forced air cooling
- Large evaporator coil virtually runs the length of the cooler for efficient balanced cooling
- Heavy duty vinyl or stainless steel exterior finishes
- Oversized and balanced refrigeration system
- All stainless steel top
- Stainless steel floor
- Epoxy coated evaporator to eliminate corrosion



G - Glass Door
LD - LED Lighting
S - Stainless Steel

WARRANTY 5 YEARS
PARTS, COMPRESSOR AND LABOUR

MODEL	DOORS	OPENING	STYLE	COLOUR	WIDTH	DEPTH	HEIGHT
TBB-2	2	Hinged	Solid	Black	1496	689	940
TBB-2-S	2	Hinged	Solid	Stainless	1496	689	940
TBB-2G-LD	2	Hinged	Glass	Black	1496	699	940
TBB-2G-S-LD	2	Hinged	Glass	Stainless	1496	699	940
TBB-4	3	Hinged	Solid	Black	2296	689	940
TBB-4-S	3	Hinged	Solid	Stainless	2296	689	940
TBB-4G-LD	3	Hinged	Glass	Black	2296	699	940
TBB-4G-S-LD	3	Hinged	Glass	Stainless	2296	699	940

ICE MACHINES



SELF CONTAINED ICEMAKERS
MODULAR ICEMAKERS
NUGGET ICE MAKERS
ICE FLAKERS
STORAGE BINS
ICE CUBE DISPENSERS
ICE CRUSHERS

STRATUS ICE MAKER

**NEW
PRODUCT**

Standard Features

- 6kg production
- 6kg sub-zero storage bin
- Stainless steel door
- Black exterior finish
- Food safe white plastic interior
- Simple, reliable ice production system
- No drain connection required
- Fully automatic operation
- Crescent shaped ice cubes
- Front mounted mains on/off switch
- Front venting, can be built in
- Reversible door
- Removable storage bin for easy cleaning
- Complete with ice scoop for sanitary ice handling



USE OF A WATER FILTER IS HIGHLY RECOMMENDED TO REDUCE LIME SCALE, PROLONG THE LIFE OF THE ICE MAKER AND DELIVER BETTER TASTING, CLEARER ICE.



R600a



MODEL	PRODUCTION	STORAGE	CUBE STYLE	WIDTH	DEPTH	HEIGHT	LIST PRICE
S6C	6kg	6kg	Crescent	430	496	660	£350
H11MCKIT			Inline water filter suitable for S6C				£40

**NEW
PRODUCT**

Standard Features

- 22kg production per 24 hours
- 6kg insulated storage bin
- Vertical evaporator production system
- Mains connected for fully automatic operation
- Dice shaped ice cubes
- Stainless steel construction
- Small footprint design for easy installation
- Intelligent electronic controls
- Adjustable ice thickness
- Electronic timer for ice production
- Self cleaning cycle
- Condenser air filter for easy maintenance

**1
YEAR
PARTS
ONLY
WARRANTY**

USE OF A WATER FILTER IS HIGHLY RECOMMENDED TO REDUCE LIME SCALE, PROLONG THE LIFE OF THE ICE MAKER AND DELIVER BETTER TASTING, CLEARER ICE.

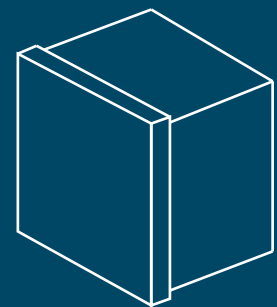
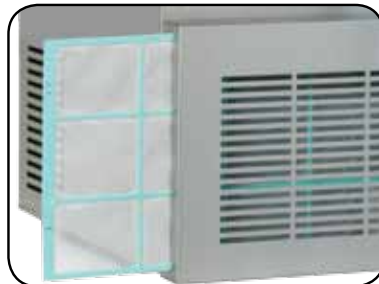

DICE SHAPED CUBE

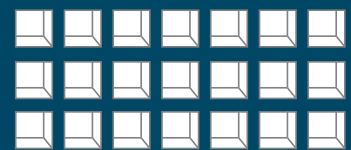

VERTICAL EVAPORATOR

R290



MODEL	PRODUCTION	STORAGE	CUBE STYLE	WIDTH	DEPTH	HEIGHT	LIST PRICE
CL20	22kg	6kg	Dice	380	470	600	£520
H11MCKIT			Inline water filter suitable for CL20				£40

Production values calculated at 21°C ambient air temperature, 15°C water temperature

Compact Icemaker

**NEW
PRODUCT**

Standard Features

- Vertical evaporator production system
- Mains connected for fully automatic operation
- Dice shaped ice cubes
- Stainless steel construction
- Small footprint design for easy installation
- Intelligent electronic controls
- Adjustable ice thickness
- Self cleaning cycle
- Condenser cleaning reminder alarm
- Condenser air filter for easy maintenance
- Environmentally friendly R290 hydrocarbon refrigerant



DICE SHAPED CUBE



VERTICAL EVAPORATOR



USE OF A WATER FILTER IS HIGHLY RECOMMENDED TO REDUCE LIME SCALE, PROLONG THE LIFE OF THE ICE MAKER AND DELIVER BETTER TASTING, CLEARER ICE.



MODEL	PRODUCTION	STORAGE	CUBE STYLE	WIDTH	DEPTH	HEIGHT	LIST PRICE
CL40	45kg	13kg	Cube	505	656	910	£1000
CL60	62kg	22kg	Cube	610	656	910	£1200
CL90	102kg	32kg	Cube	715	656	910	£1600
H11MCKIT	Inline water filter suitable for CL40						£40
4HKIT	Filter cartridge kit suitable for CL60 & CL90						£170

CLM SERIES ICE MAKERS

**NEW
PRODUCT**

Standard Features

- Vertical evaporator production system
- Mains connected for fully automatic operation
- Dice shaped ice cubes
- Stainless steel construction
- Includes 180kg storage bin
- Intelligent electronic controls
- Adjustable ice thickness
- Self cleaning cycle
- Condenser cleaning reminder alarm
- Condenser air filter for easy maintenance
- Environmentally friendly R290 hydrocarbon refrigerant

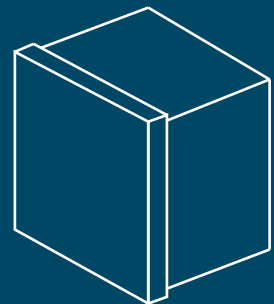

DICE SHAPED CUBE



VERTICAL EVAPORATOR

R290



HYDROCARBON
REFRIGERANT
COLDER BY NATURE



Prodis
CL210M



USE OF A WATER FILTER IS HIGHLY RECOMMENDED TO REDUCE LIME SCALE, PROLONG THE LIFE OF THE ICE MAKER AND DELIVER BETTER TASTING, CLEARER ICE.

MODEL	PRODUCTION	STORAGE	CUBE STYLE	WIDTH	DEPTH	HEIGHT	LIST PRICE
CL210M	210kg	180kg	Cube	780	805	1720	£3000
4HKIT			Filter cartridge kit suitable for CL210M				£170

Prodis

C SERIES ICE MAKERS



Standard Features

- Designed specifically for the hospitality industry
- Crystal clear, super hard, slow melting ice cubes
- European manufactured to ISO9001 standards
- Proven and reliable ice production system
- Front venting
- High drain exit height for easy installation
- Patented flexible spray jets to minimise lime scale build-up
- Front mounted mains on off switch
- Injected HCFC free polyurethane for outstanding insulation
- 2 year parts warranty as standard

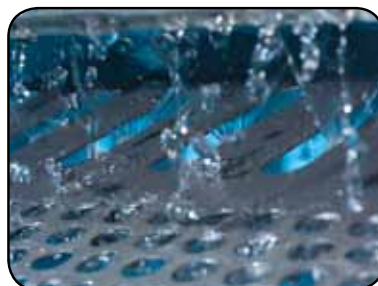

USE OF A WATER FILTER IS HIGHLY RECOMMENDED TO REDUCE LIME SCALE, PROLONG THE LIFE OF THE ICE MAKER AND DELIVER BETTER TASTING, CLEARER ICE.



C SERIES ICE MAKERS



C25



C35



C45



C60

2
YEAR
PARTS
ONLY
WARRANTY

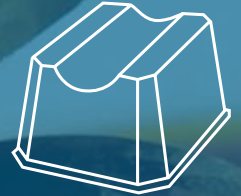

Rhomboid Style Cube
C25



Gourmet Style Cube
C35, C45, C60, C80, C135



C80



C135

MODEL	PRODUCTION	STORAGE	CUBE STYLE	WIDTH	DEPTH	HEIGHT	LIST PRICE
C25	23kg	6kg	Rhomboid	350	475	590	£970
C35	41kg	15kg	Gourmet	435	605	695 ¹	£1280
C45	46kg	15kg	Gourmet	435	605	695 ¹	£1420
C60	62kg	30kg	Gourmet	515	645	840 ¹	£1700
C80	72kg	40kg	Gourmet	645	645	870 ²	£2225
C135	111kg	60kg	Gourmet	930	565	915 ²	£2635
H11MCKIT		Inline water filter suitable for C25, C35, C45					£40
4HKIT		Filter cartridge kit suitable for C60, C80, C135					£170



¹+12mm to 20mm adjustable feet
²+105mm to 155mm adjustable feet

PS SERIES ICE MAKERS



Paddle System

Standard Features

- Paddle system production
- Ideal for hard water areas
- Operates without thermostats
- Can be installed in ambient temperatures as low as 5°C or as high as 43°C
- Ideal production to storage ratios
- AISI 304 stainless steel construction
- Space saving inward opening door
- Mains on/off switch
- Tropicalised condensing unit
- R452a refrigerant



PS25

PS35

PS40

PS55



USE OF A WATER FILTER IS HIGHLY RECOMMENDED TO REDUCE LIME SCALE, PROLONG THE LIFE OF THE ICE MAKER AND DELIVER BETTER TASTING, CLEARER ICE.

PS SERIES ICE MAKERS

PS Series - specifically designed as a fully electromechanical ice maker which does not require a thermostat to operate.

The full ice making process is controlled by micro-switches which detect when the storage bin is full of ice to stop production.

This unique method allows the PS Series to be installed in ambient temperatures as low as +5°C making them ideal for installation in cellars and unheated rooms.

(Excl. PS180M)



PS75



PS135



PS180M + S230 Storage Silo

MODEL	PRODUCTION	STORAGE	CUBE STYLE	WIDTH	DEPTH	HEIGHT	LIST PRICE
PS25	26kg	9kg	Bullet	401	506	643 ¹	£1350
PS35	31kg	12kg	Bullet	401	506	698 ¹	£1630
PS40	41kg	12kg	Bullet	401	506	698 ¹	£1945
PS55	59kg	30kg	Bullet	594	557	934 ²	£2100
PS75	83kg	37kg	Bullet	647	557	984 ²	£2410
PS135	135kg	100kg	Bullet	812	762	1398 ³	£4255
PS180M	180kg	Modular	Bullet - L	840	700	1125	£4615
H11MCKIT	Inline water filter suitable for PS25, PS35, PS40						£40
4HKIT	Filter cartridge kit suitable for PS55, PS75, PS135, PS180M						£170

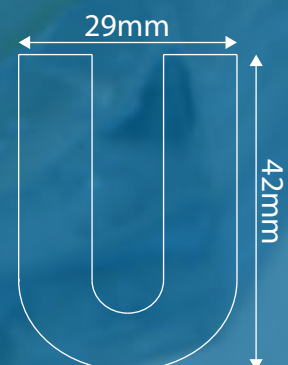

¹ +13mm to 57mm adjustable feet, ² +105mm to 155mm adjustable feet, ³ +117mm -140mm adjustable feet

CD SERIES NUGGET ICE MAKERS



Axial Production System

Standard Features

- Vertical evaporator production
- Heavy duty auger
- Diamond ice production
- European manufactured to ISO9001 standards
- Electromechanical operation for high reliability
- External on/off switch
- Stainless steel construction
- R290 refrigerant



2
YEAR
PARTS
ONLY
WARRANTY

USE OF A WATER FILTER IS HIGHLY RECOMMENDED TO REDUCE LIME SCALE, PROLONG THE LIFE OF THE ICE MAKER AND DELIVER BETTER TASTING, CLEARER ICE.



MODEL	PRODUCTION	STORAGE	CUBE STYLE	WIDTH	DEPTH	HEIGHT	LIST PRICE
CD90	94kg	20kg	Diamond	465	595	790 ¹	£3010
4HKIT	Filter cartridge kit suitable for CD90						£170

N SERIES NUGGET ICE MAKER



Axial Production System

Standard Features

- Vertical evaporator production
- Heavy duty auger
- Nugget ice production
- European manufactured to ISO9001 standards
- Electromechanical operation for high reliability
- External on/off switch
- Stainless steel construction
- R452 refrigerant



N300 + S180 Silo

Production values calculated at 21°C ambient air temperature, 15°C water temperature



USE OF A WATER FILTER IS HIGHLY RECOMMENDED TO REDUCE LIME SCALE, PROLONG THE LIFE OF THE ICE MAKER AND DELIVER BETTER TASTING, CLEARER ICE.



ICE MAKERS							
MODEL	PRODUCTION	STORAGE	CUBE STYLE	WIDTH	DEPTH	HEIGHT	LIST PRICE
N300	335kg	-	Nugget	559	622	712	£6330
4HKIT	Filter cartridge kit suitable for N300						£170
SUGGESTED STORAGE BINS (SEE PAGE 94 FOR MORE OPTIONS)							
S180	-	181kg	-	559	872	1275	£1525
S230	-	230kg	-	762	819	1224	£1650
S390	-	390kg	-	1219	819	1224	£2310

C SERIES M MODULAR ICE MAKERS



Vertical Evaporator System

Standard Features

- Specifically designed to cope in even the most demanding venues
- Classic dice shaped ice cube
- Proven and reliable vertical evaporator production system
- Built in self cleaning cycle
- Units can be double stacked for venues where constant ice production is a must
- AISI304 stainless steel construction
- Tropicalised condensing unit
- Can operate in ambient temperatures up to 43°C
- R452a refrigerant

Options

- Half dice ice cube
- Remote refrigeration
- Water cooled condensing units



C220M + S230 Silo



Production values calculated at 21°C ambient air temperature, 15°C water temperature

USE OF A WATER FILTER IS HIGHLY RECOMMENDED TO REDUCE LIME SCALE, PROLONG THE LIFE OF THE ICE MAKER AND DELIVER BETTER TASTING, CLEARER ICE.



C SERIES M MODULAR ICE MAKERS



Full dice ice cube



2 x C220M + S230 Silo
(requires union kit)



C405M + S390 Silo

ICE MAKERS

MODEL	PRODUCTION	STORAGE	CUBE STYLE	WIDTH	DEPTH	HEIGHT	LIST PRICE
C220M	220kg	-	Full Dice	762	620	500	£3315
C300M	305kg	-	Full Dice	559	621	659	£4655
C405M	405kg	-	Full Dice	762	620	760	£4355
4HKIT	Filter cartridge kit suitable for C220M, C300M, C405M						£170

SUGGESTED STORAGE BINS (SEE PAGE 94 FOR MORE OPTIONS)

S180	-	181kg	-	559	872	1275	£1525
S230	-	230kg	-	762	819	1224	£1650
S390	-	390kg	-	1219	819	1224	£2310
SCMUK	Stacking Union Kit						£490

GR SERIES ICE FLAKERS



Axial Production System

Standard Features

- Heavy duty auger production system
- Immediate and constant production
- Fully electromechanical operation
- Supplied complete with scoop
- AISI304 stainless steel construction
- Tropicalised condensing unit
- Low power and water consumption
- Suitable for use in ambient temperatures up to 43°C
- R452a refrigerant

Options

- Remote refrigeration
- Water cooled condensing units



GR220 installed on S230 storage silo



GR135



Production values calculated at 21°C ambient air temperature, 15°C water temperature



2 x GR220 installed on S340 storage silo



USE OF A WATER FILTER IS HIGHLY RECOMMENDED TO REDUCE LIME SCALE, PROLONG THE LIFE OF THE ICE MAKER AND DELIVER BETTER TASTING, CLEARER ICE.

ICE MAKERS

MODEL	PRODUCTION	STORAGE	CUBE STYLE	WIDTH	DEPTH	HEIGHT	LIST PRICE
GR135	135kg	40kg	Flaked	515	550	1355	£3955
GR140	140kg	-	Flaked	515	550	486	£3730
GR220	220kg	-	Flaked	515	550	575	£4090
GR390	390kg	-	Flaked	675	550	660	£5060
GR565	550kg	-	Flaked	675	550	800	£5860
GR1125	1160kg	-	Flaked	1335	610	815	£11330
4HKIT	Filter cartridge kit suitable for GR135, GR140, GR220, GR390						£170
SUGGESTED STORAGE BINS (SEE PAGE 94 FOR MORE OPTIONS)							
S230	-	230kg	-	762	819	1224	£1650
S340	-	340kg	-	1067	819	1224	£2195



Storage Silos

Standard Features

- AISI 304 stainless steel construction
- Insulated with polyurethane
- Durable & sanitary one-piece polyethylene seamless interior
- Rounded interior corners for easy cleaning
- Heavy duty, quiet door closing mechanism
- Range of sizes available to suit all needs
- Adjustable feet



S230



S230 Storage Silo + C220M

S390 Storage Silo + C405M



MODEL	STORAGE	WIDTH	DEPTH	HEIGHT	LIST PRICE
S180	181kg	559	872	1275	£1525
S230	230kg	762	819	1224	£1650
S340	340kg	1067	819	1224	£2195
S390	390kg	1219	819	1224	£2310
S480	480kg	1321	872	1275	£2670

SC SERIES ICE TRANSPORT

SC Series ice storage and distribution system has been designed to allow large volumes of ice to be distributed. The SC series is ideal for larger venues, stadiums, hospitals and supermarkets where one central icemaker can easily supply multiple outlets.

Bin Features

- Range of storage bins from 140kg to 830kg of ice
- AISI 304 stainless steel storage bins
- Rounded interior corners for easy cleaning
- All bins supplied with EZ cart which adds an additional 112kg of storage per cart

EZ Cart Features

- Brake system for safe operation
- Drain system for easy cleaning
- Constructed from durable polyethylene for sanitary operation
- Rounded interior corners for easy cleaning
- Cover included to prevent contamination
- Optional tote kit can be installed into the EZ cart to allow for easier distribution of ice



SDC400

2
YEAR
PARTS
ONLY
WARRANTY

SPECIAL ORDER



SC140



SC300



SDC600

MODEL	STORAGE	CARTS	WIDTH	DEPTH	HEIGHT	LIST PRICE
SC140	140kg	1 x 112kg	762	1016	1320	£5060
SC300	300kg	1 x 112kg	762	1016	1865	£6975
SCD400	413kg	2 x 112kg	1524	1016	1520	£9775
SCD600	617kg	2 x 112kg	1524	1016	1820	£11640
SCD830	812kg	2 x 112kg	1524	1016	2084	£12770
OPTIONS						
EZCART	112kg		622	1054	887	£1390
TOTEKIT	70kg					£720

Ice Machine
C220M 500mm
C300M 659mm
C405M 760mm

1218 / 1371 mm

1383 / 1536mm

559 / 769mm

2
YEAR
PARTS
ONLY
WARRANTY

SPECIAL ORDER



Standard Features

- AISI304 stainless steel construction
- Built in lighting in dispensing area
- Adjustable legs
- 109 grams/second dispensing speed
- Optional built in water dispenser
- Easy to operate anti-freeze dispensing mechanism
- Designed to be used with C220M, C300M & C405M modular icemakers

MODEL	STORAGE	WATER DISPENSER	WIDTH	DEPTH	HEIGHT	LIST PRICE
SD60	58kg	No	559	835	1371	£4370
SD60W	58kg	Yes	559	835	1371	£4470
SD100	104kg	No	769	835	1537	£4470
SD100W	104kg	Yes	769	835	1537	£4560

S SERIES

SILO GUIDE

Quick reference chart for installation of Prodis modular icemakers on to modular storage bins.

Where a stacked configuration is specified a union adaptor is required to be installed between the two icemakers. Stacked configuration is only available on C Series models.

Legend

- Optimal production to storage ratio
- Sub-optimal production to storage ratio
- Single configuration
- Side by side configuration
- Double stacked configuration (Requires union kit)

Model	Storage Silos										
	S180		S230		S340		S390		S480		
	1	2	1	2	1	2	1	2	1	2	
Machines											
C220M			●	●●	●	●●	●	●●	●	●●	
C300M	●		●		●		●		●		
C405M			●	●●	●	●●	●	●●	●	●●	
PS180M			●		●		●		●		
N300	●		●		●		●		●		
GR140	●		●		●	●●	●	●●	●	●●	
GR220	●		●		●	●●	●	●●	●	●●	
GR390			●		●		●		●	●●	
GR565			●		●		●		●	●●	
GR1125									●		

Model	Ice Transport										
	SC140		SC300		SCD400		SCD600		SCD830		
	1	2	1	2	1	2	1	2	1	2	
Machines											
C220M	●	●	●	●●	●	●●	●	●●	●	●●	
C300M	●		●		●						
C405M	●	●	●	●	●	●●	●	●●	●	●●	
PS180M	●		●		●	●●	●	●●	●	●●	
N300	●		●		●	●●	●	●●	●	●●	
GR140	●		●		●	●●	●	●●	●	●●	
GR220	●		●		●	●●	●	●●	●	●●	
GR390	●		●		●	●●	●	●●	●	●●	
GR565	●		●		●	●●	●	●●	●	●●	
GR1125					●		●		●		

Model	Ice Dispensers							
	SD60		SD60W		SD100		SD100W	
	1	2	1	2	1	2	1	2
Machines								
C220M					●		●	
C300M	●		●					
C405M					●		●	

Prodis

CR SERIES

ICE CRUSHERS



The CR Series ice crusher is a space saving, compact solution for venues that have a need for crushed ice. Cocktails, food presentation and preservation are some of its many uses.

The CR series are also useful for sports injuries as well as physiotherapy applications.

The CR3 and CR5 are fitted with a heavy duty and durable stainless steel crushing mechanism which delivers crushed ice in seconds.

The heavy duty CR series are capable of delivering up to 300kg of crushed ice per hour.

2
YEAR
PARTS
ONLY
WARRANTY

Standard Features

- Heavy duty stainless steel crushing mechanism
- Full stainless steel construction
- Removable ice storage bin
- Compact elegant counter top design
- 13amp operation



MODEL	CAPACITY	STORAGE	WIDTH	DEPTH	HEIGHT	LIST PRICE
CR3	3kg / minute	1kg	180	330	320	£1500
CR5	5kg / minute	5kg	370	310	510	£2635

Ice Type & Production System

CRESCENT

Crescent ice as the name suggests is half-moon in shape, the ergonomic shape of the ice cube allows liquid to flow easily over it allowing for an even pour without the risk of splashing. This type of ice is perfect for most drinks and the cloudiness of the ice allows for easy blending or crushing for perfect smoothies and cocktails. The unique shape also allows for maximum storage within the ice bin, leaving less air between cubes when they are packed together.

BULLET

Softer than a Gourmet cube but faster to cool drinks thanks to its hollow centre and increased surface area. The bullet ice cube is produced by a paddle system ice maker which is less susceptible to lime scale build up and does not use thermostats making it ideal for situating in a cellar or a room with a low ambient temperature.

CUBED/DICE

Clear, dice shaped ice cubes, produced by a vertical evaporator this type of ice is ideal for nightclubs, large bars or fast food establishments where a large volume of ice is in constant demand.

DIAMOND

As the name suggests diamond ice is small and irregular in shape, similar in appearance to crushed ice and perfect for cocktails and food presentation. The diamond ice is produced using an augur which shaves flakes of ice from the evaporator and then recompresses them into the diamond shape.

GOURMET

Clear Gourmet shaped ice cubes, produced using a spray system these cubes are crystal clear, super hard and slow to melt. This type of cube is perfect for specialist drinks where a slow melt time and crystal clear appearance will enhance the customers experience.

NUGGET

Similar to diamond ice but larger and harder nugget ice is the perfect solution for cocktail bars where a large volume of crushed type ice is required.

RHOMBOID

Similar to a Gourmet cube in production, appearance and characteristics but smaller in physical size, this cube is also ideal for specialist drinks where a slow melt time and crystal clear appearance will enhance the customers experience.

FLAKED

Flaked ice is ideal for food presentation in supermarkets, fishmongers and restaurants, the large surface area and low moisture content make it ideal to cool foods for a long period of time. Produced using an augur ice flakers can produce anywhere between 130kg and 1000kg a day.

ice Machine Storage

The storage capacity of your ice maker is as important and sometimes more important than the production value. Your ice maker is rated to produce a certain amount of ice per day, however once the storage bin is full the ice maker will automatically stop producing. The correct storage capacity to production ratio is crucial in selecting an ice maker which will meet the demands of the customer in terms of having enough ice available at the start of trading and ice being replenished throughout the day.

Nightclubs, stadiums and event venues require a large storage to production ratio to ensure that there is a large volume of ice available at the start of the short trading period. Pubs, bars, restaurants and cafes can use a smaller production to storage ratio so that ice production is spread evenly throughout the trading day ensuring there is always fresh ice available for the customer.

Larger venues, supermarkets, fish markets and stadiums can benefit from using an ice transport system instead of a storage bin, enabling large volumes of ice to be moved around easily using a cart.

DISPLAY REFRIGERATION



TRUE
REFRIGERATION®

Prodis

GLASS DOOR COOLERS
MULTIDECK DISPLAYS
SERVE OVER COUNTERS
FRESH FISH DISPLAYS
PÂTISSERIE COUNTERS



XD PRO SERIES DISPLAY REFRIGERATION

FORCED AIR

AUTOMATIC DEFROST

DIGITAL CONTROL

LED ILLUMINATION

LOCKABLE DOOR

SELF CLOSING DOOR



The XD PRO series has been designed and manufactured to cope in even the most demanding retail environments.

Available as matching fridges and freezers to allow you to create a seamless run of refrigeration.

The XD PRO series features forced air cooling and frost free operation for ease of use for the operator. Twin vertical LED interior lighting makes the product stand out and brilliantly illuminates the contents driving sales.

Self closing doors as standard increase energy efficiency and user friendliness by always ensuring the cabinet is closed when not in use.

Featuring a digital temperature controller for ease of operation and at a glance temperature read out the XD PRO series is easy to use and simple to monitor even in the busiest shop.

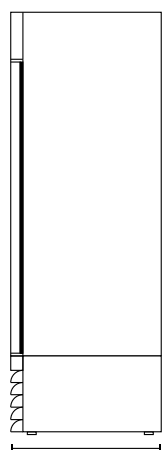
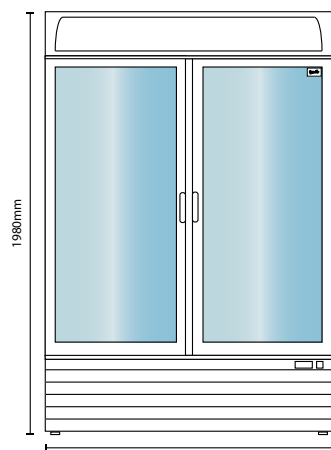
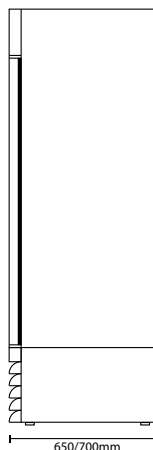
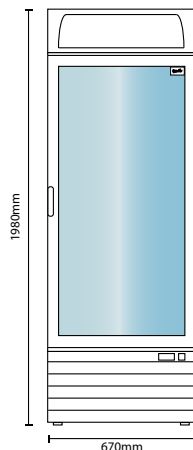



Space saving recessed door handles



Large volume evaporator fan for even temperature distribution throughout the entire cabinet



Intelligent electronic temperature controller and external light switch



Lockable doors for added security



Illuminated merchandising canopy for quick and effective branding

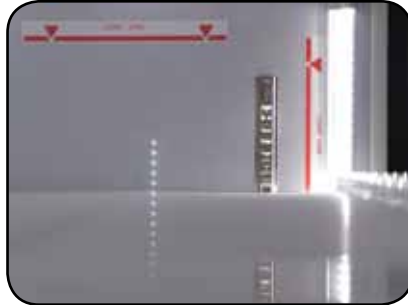

High visibility load lines to assist in even air circulation



Shelf edge ticket strips on each shelf as standard



Rear load guard to ensure optimum airflow at all times

Standard Features

- Frost free operation
- Automatic defrost
- Forced air cooling
- Digital temperature controller
- Matching fridge and freezer
- White exterior & interior finish
- Illuminated merchandising canopy
- Twin vertical LED internal illumination
- Self closing doors
- 5 adjustable shelves per door
- Shelf edge ticket strips
- Lockable door
- Replaceable door gaskets

MODEL	COLOUR	TEMPERATURE	CAPACITY	WIDTH	DEPTH	HEIGHT	LIST PRICE
XD2PW	White	+2°C to +8°C	730 Litres	1220	700	1985	£1540
XD2NW	White	-18°C to -22°C	730 Litres	1220	700	1985	£2480



Prodis

XD SERIES
DISPLAY
REFRIGERATION

FORCED AIR

AUTOMATIC DEFROST

LED ILLUMINATION

LOCKABLE DOOR

SELF CLOSING DOOR

Standard Features

- +2°C to +10°C temperature range
- Forced air refrigeration
- Lockable hinged door
- Vertical internal illumination
- 4 fully adjustable shelves + base
- White exterior finish
- White interior
- Double glazed door
- Illuminated merchandising canopy

**NEW
PRODUCT**

R290



HYDROCARBON
REFRIGERANT
COLDER BY NATURE



MODEL	TEMPERATURE	SHELVES	CAPACITY	WIDTH	DEPTH	HEIGHT	LIST PRICE
XD260C	+2°C to +10°C	4 + Base	260 litres	525	561	1752	£590

XD SERIES DISPLAY REFRIGERATION

FAN ASSISTED COOLING

AUTOMATIC DEFROST

INTERIOR LIGHTING

1
YEAR
PARTS
ONLY
WARRANTY

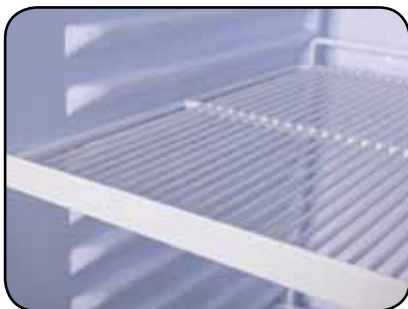

XD380

Standard Features

- Fan assisted cooling
- Internal illumination
- 5 x adjustable shelves
- Food safe plastic interior
- Double glazed door
- Adjustable thermostat
- +1°C to +10°C temperature range
- White exterior finish
- Black door trim
- Double glazed door
- Off cycle defrost

MODEL	CAPACITY	SHELVES	COLOUR	WIDTH	DEPTH	HEIGHT	LIST PRICE
XD380	372 Litres	5	White	595	650	1865	£660
XDSH			Additional Flat White Wire Shelves				£44

R600a



HYDROCARBON
REFRIGERANT
COLDER BY NATURE

XD SERIES DISPLAY REFRIGERATION

FORCED AIR

AUTOMATIC DEFROST

DIGITAL CONTROL

LED ILLUMINATION

LOCKABLE DOOR

SELF CLOSING DOOR

Standard Features

- +2°C to +10°C temperature range
- Forced air refrigeration
- Lockable hinged doors
- Self closing doors
- Externally mounted light switch
- Vertical internal illumination
- 8 fully adjustable shelves + base
- White exterior finish
- Digital temperature control
- Digital temperature display
- Automatic defrost
- White interior
- Double glazed doors
- Illuminated merchandising canopy

**NEW
PRODUCT**

R290

HYDROCARBON
REFRIGERANT
COLDER BY NATURE



MODEL	COLOUR	SHELVES	CAPACITY	WIDTH	DEPTH	HEIGHT	LIST PRICE	
XD701	White	8	700 Litres	1120	610	1973	£1190	
XD1201	White	8	1250 Litres	1330	690	2079	£1460	
GLIDE701		XD Glide gravity feed shelving system for XD701 (per shelf)						£54
GLIDE1201		XD Glide gravity feed shelving system for XD1201 (per shelf)						£64

2
YEAR
PARTS
&
LABOUR
WARRANTY



FAN ASSISTED COOLING

AUTOMATIC DEFROST

DIGITAL CONTROL

LED ILLUMINATION

LOCKABLE DOOR

REVERSIBLE DOOR

Standard Features

- Fan assisted cooling
- Internal illumination
- Food safe plastic interior
- Replaceable door gasket
- Digital temperature control
- +2°C to +10°C temperature range
- White exterior finish
- Aluminium door frame
- Double glazed door
- Automatic defrost
- R600a refrigerant



MODEL	COLOUR	SHELVES	CAPACITY	WIDTH	DEPTH	HEIGHT	LIST PRICE
HC201G	White	3	129 Litres	600	600	850	£640
HC401G	White	6	361 Litres	600	600	1850	£930

R600a



**HYDROCARBON
REFRIGERANT
COLDER BY NATURE**

GDM-SERIES
DISPLAY COOLERS

- FORCED AIR**
- AUTOMATIC DEFROST**
- LED ILLUMINATION**
- SELF CLOSING DOOR**

Standard Features

- 4 shelves per section
- Forced air refrigeration
- Positive seal self-closing doors
- White aluminium interior and 300 series stainless steel floor
- Fridges hold 0.5°C to 3.3°C
- Adjustable heavy duty PVC coated wire shelves
- Built in the U.S.A.
- 5 year parts and labour warranty

HC - Hydrocarbon
TSL01 - True Standard Look 01
LD - Led Lighting



MODEL	STYLE	DOORS	FINISH	CAPACITY	WIDTH	DEPTH	HEIGHT
GDM-19T-HC~TSL01	Hinged door	1		466 Litres	686	632	1998
GDM-23-HC~TSL01	Hinged door	1		589 Litres	686	759	1998
GDM-33-HC-LD	Sliding doors	2		890 Litres	1004	753	1998
GDM-35-HC~TSL01	Hinged doors	2		900 Litres	1004	759	1998
GDM-37-LD	Sliding doors	2		1059 Litres	1105	753	1998
GDM-41-LD	Sliding doors	2		1161 Litres	1197	753	1998
GDM-45-LD	Sliding doors	2		1275 Litres	1299	753	1998
GDM-47-LD	Sliding doors	2		1331 Litres	1375	753	1998
GDM-49~TSL01	Hinged doors	2		1388 Litres	1375	759	1998
GDM-69-LD	Sliding doors	3		1954 Litres	1985	753	1998
GDM-72~TSL01	Hinged doors	3		2039 Litres	1985	759	1998

GRANDE VISTA DISPLAY FREEZERS



2
YEAR
PARTS
ONLY
WARRANTY

Standard Features

- 4 sizes available
- Attractive curved glass lid
- Sliding lids
- Maximum visibility
- Full set of baskets as standard
- Castors fitted as standard
- Stylish grey surround
- White exterior
- Aluminium interior
- Digital temperature display
- Adjustable thermostat
- 70mm thick insulation
- Static cooling
- Manual defrost
- Defrost drain hole
- Fan assisted condenser
- Low noise design
- Low energy consumption
- Castors as standard
- -18°C to -24°C temperature range
- Climate class ST

Baskets

All Grande Vista display freezers are supplied with a full set of baskets as standard.

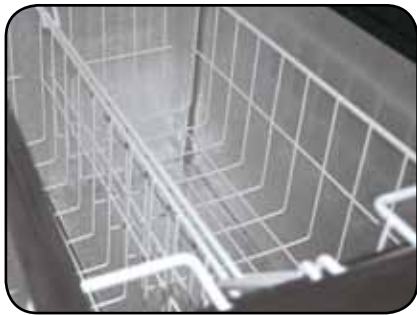

Control

All Grande Vista display freezers are equipped with digital thermometer and dial thermostat.



Lids

All Grande Vista display freezers have attractive curved sliding glass lids.



**INCLUDES FULL
SET OF BASKETS**

MODEL	CAPACITY	BASKETS	TEMPERATURE	WIDTH	DEPTH	HEIGHT	LIST PRICE
GV1	240 Litres	3	-18°C to -24°C	1045	695	860	£690
GV2	309 Litres	4	-18°C to -24°C	1275	695	860	£750
GV3	395 Litres	5	-18°C to -24°C	1535	695	860	£850
GV4	480 Litres	6	-18°C to -24°C	1815	695	860	£950



FORCED AIR

AUTOMATIC DEFROST

DIGITAL CONTROL

LED ILLUMINATION

Standard Features

- Ventilated cooling system
- Part glazed end panels
- White frontal decoration
- White interior
- Frontal glass
- 4 fully adjustable shelves (height and angle) + base
- Night blind
- Automatic evaporation
- Digital temperature control
- Interior lighting
- Adjustable feet
- Climate class 3 (25°C/60% R.H)

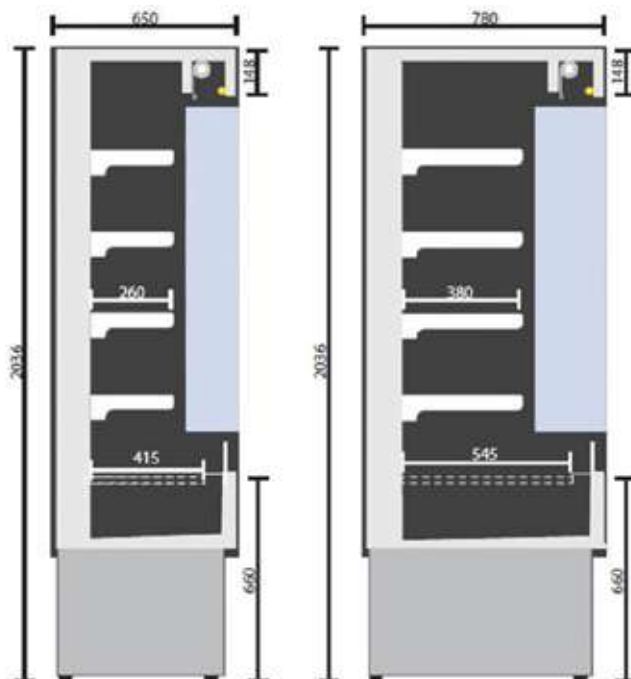

1
YEAR
PARTS ONLY
WARRANTY

SPECIAL ORDER

COFFEE



Aruba multideck in RAL 2000 with matching Araya serve over counters



Optional custom RAL coloured front panels
Stock front panel colour - white



Optional EPOS ticket strips



Optional shelf risers



Optional tray slide support



Aruba with fully glazed doors and solid end panels

Optional Features

- Custom coloured front panels
- Frontal shelf risers
- EPOS ticket strips
- Under shelf lighting
- Tray slide support
- Solid end panels
- Fully glazed doors

MODEL	SHELF WIDTH	BASE DEPTH	TEMP RANGE	WIDTH	DEPTH	HEIGHT	LIST PRICE
A60/100	1000 x 260	415mm	+4°C to +7°C	1070	650	2036	£3900
A60/125	1250 x 260	415mm	+4°C to +7°C	1320	650	2036	£4100
A60/150	1500 x 260	415mm	+4°C to +7°C	1570	650	2036	£4550
A60/200	2000 x 260	415mm	+4°C to +7°C	2070	650	2036	£5100
A80/100	1000 x 380	545mm	+4°C to +7°C	1070	780	2036	£4000
A80/125	1250 x 380	545mm	+4°C to +7°C	1320	780	2036	£4200
A80/150	1500 x 380	545mm	+4°C to +7°C	1570	780	2036	£4650
A80/200	2000 x 380	545mm	+4°C to +7°C	2070	780	2036	£5200

FORCED AIR

AUTOMATIC DEFROST

DIGITAL CONTROL

LED ILLUMINATION

Standard Features

- Ventilated cooling system
- Part glazed end panels
- White frontal decoration
- Shelf risers as standard
- White interior
- Frontal glass
- 3 fully adjustable shelves (height and angle) + base
- Night blind
- Automatic evaporation
- Digital temperature control
- Interior lighting
- Adjustable feet
- Climate class 3 (25°C/60% R.H)

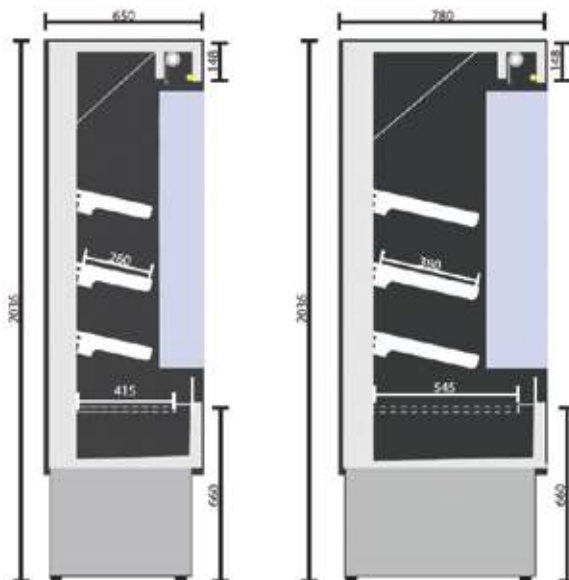

1
YEAR
PARTS ONLY
WARRANTY

SPECIAL ORDER



Aruba-FV multideck fitted with optional solid end panels

Optional Features

- Custom coloured front panels
- Under shelf lighting
- Tray slide support
- Solid end panels



Optional custom RAL coloured front panels
Stock front panel colour - white



Optional EPOS ticket strips

MODEL	SHELF WIDTH	BASE DEPTH	TEMP RANGE	WIDTH	DEPTH	HEIGHT	LIST PRICE
A60/100-FV	1000 x 260	415mm	+4°C to +7°C	1070	650	2036	£3950
A60/125-FV	1250 x 260	415mm	+4°C to +7°C	1320	650	2036	£4200
A60/150-FV	1500 x 260	415mm	+4°C to +7°C	1570	650	2036	£4650
A60/200-FV	2000 x 260	415mm	+4°C to +7°C	2070	650	2036	£5200
A80/100-FV	1000 x 380	545mm	+4°C to +7°C	1070	780	2036	£4050
A80/125-FV	1250 x 380	545mm	+4°C to +7°C	1320	780	2036	£4250
A80/150-FV	1500 x 380	545mm	+4°C to +7°C	1570	780	2036	£4700
A80/200-FV	2000 x 380	545mm	+4°C to +7°C	2070	780	2036	£5250

CALGARY MKII MULTIDECK DISPLAYS

FORCED AIR

AUTOMATIC DEFROST

DIGITAL CONTROL

LED ILLUMINATION

Standard Features

- Slimline low front design
- LED side and top illumination
- Slow rise night blind as standard
- 5 fully adjustable (height and angle) shelves + base
- Shelf edge ticket strips as standard
- Acrylic shelf risers as standard
- White exterior and interior finish
- Fully glazed end panels
- Adjustable feet
- Electronic temperature display and control
- Fully automatic operation
- Automatic defrost
- R448a refrigerant

Optional Features

- Solid end panels¹

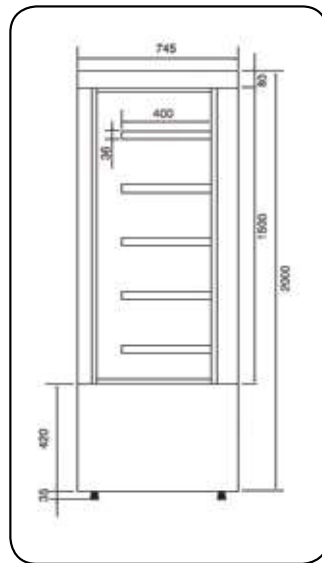

MODEL	TEMPERATURE	DISPLAY AREA	SHELF WIDTH	WIDTH	DEPTH	HEIGHT	LIST PRICE
CMII-10	-1°C to +7°C	2.21m ²	920mm	1000	745	2000	£3860
CMII-12	-1°C to +7°C	2.67m ²	1120mm	1200	745	2000	£4210
CMII-20	-1°C to +7°C	4.57m ²	2 x 952mm	2000	745	2000	£5380
CMII-24	-1°C to +7°C	5.37m ²	2 x 1140mm	2400	745	2000	£6250

¹Additional lead time



FAN ASSISTED COOLING

AUTOMATIC DEFROST

DIGITAL CONTROL

INTERIOR LIGHTING

Standard Features

- Curved glass refrigerated display
- Refrigerated under storage
- Large 550mm deep white display deck
- Semi-ventilated counter
- Automatic defrost
- Electronically controlled
- Temperature display
- Intermediate ambient glass shelf
- Internal illumination
- +1°C to +7°C temperature range

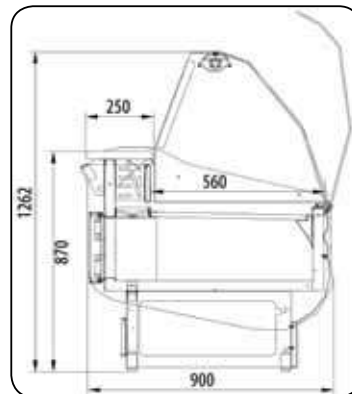

1
YEAR
PARTS
ONLY
WARRANTY

MODEL	REAR DOORS	DECK SIZE	CAPACITY	WIDTH	DEPTH	HEIGHT	LIST PRICE
M100	1	0.55m ²	166 Litres	1000	898	1262	£2500
M150	2	0.83m ²	249 Litres	1520	898	1262	£2900
M200	2	1.1m ²	332 Litres	2000	898	1262	£3600
M250	3	1.38m ²	415 Litres	2480	898	1262	£3900
M300	3	1.66m ²	498 Litres	2960	898	1262	£4530

FAN ASSISTED COOLING

AUTOMATIC DEFROST

DIGITAL CONTROL

LED ILLUMINATION

Standard Features

- Flat glass refrigerated display cabinet
- Refrigerated under storage
- LED interior lighting
- Ambient intermediate shelf
- Lightweight design, easy to install
- Custom front panel colours available upon request
- Digital temperature controller
- Digital temperature display at rear
- Customer facing analog temperature display
- Automatic defrost
- Built in heating element below front glass to aid elimination of condensation
- +1°C to +10°C temperature range
- Toughened glass panels*
- Illuminated display deck
- 500mm deep white deck
- Switchable static or fan assisted refrigeration
- Climate class 3 (25°C 60% RH)

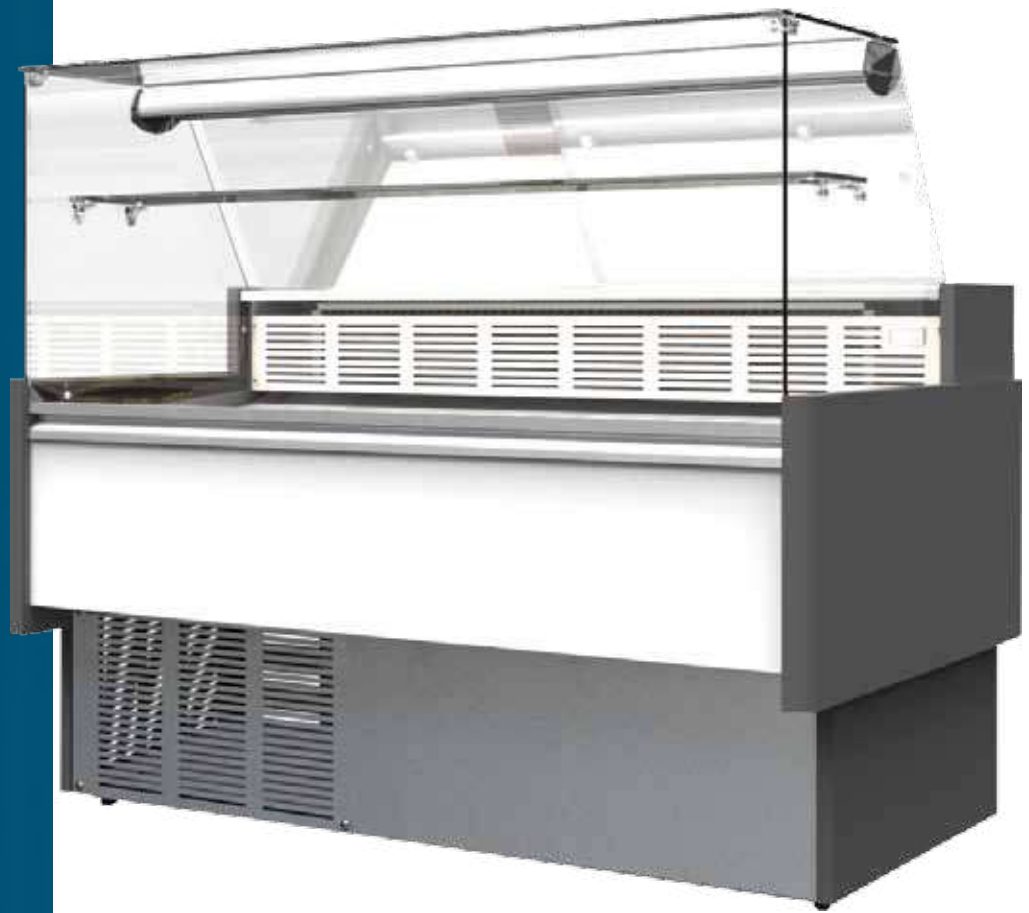

A15F with optional acrylic rear doors





Optional CXAR-CX till counter

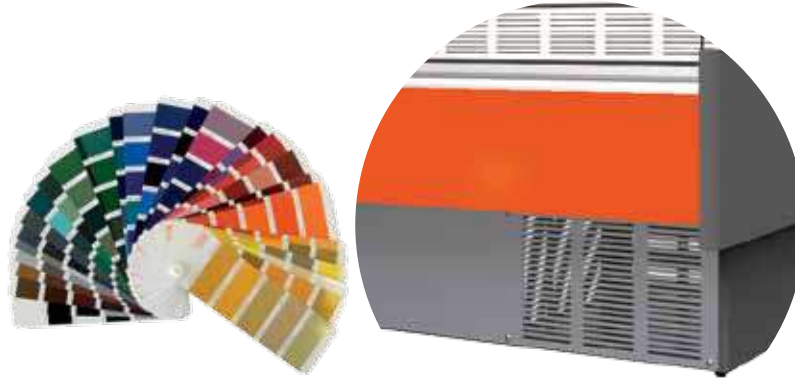

Optional custom RAL coloured front panels
Stock front panel colour - white

- Optional Features
- Custom coloured front panels
 - Castor kit
 - Till counter
 - Acrylic rear doors

MODEL	REAR DOORS	DISPLAY AREA	CAPACITY	WIDTH	DEPTH*	HEIGHT	LIST PRICE
A10F	1	0.61m ²	160 Litres	1000	833	1268	£2300
A15F	1	0.94m ²	249 Litres	1500	833	1268	£2650
A20F	2	1.28m ²	337 Litres	2000	833	1268	£3300
A25F	3	1.62m ²	426 Litres	2500	833	1268	£3550
ACCESSORIES							
CXAR-CX	Till Counter			650	798	905	£1000
PAVAR100VD	Acrylic Rear Doors A10F						£90
PAVAR150VD	Acrylic Rear Doors A15F						£120
PAVAR200VD	Acrylic Rear Doors A20F						£150
PAVAR250VD	Acrylic Rear Doors A25F						£220

*Depth can be reduced to 798mm for installation by removing rear door

FAN ASSISTED COOLING

AUTOMATIC DEFROST

DIGITAL CONTROL

LED ILLUMINATION

Standard Features

- Curved glass refrigerated display cabinet
- Refrigerated under storage
- LED interior lighting
- Ambient intermediate shelf
- Lightweight design, easy to install
- Custom front panel colours available upon request
- Digital temperature controller
- Digital temperature display at rear
- Customer facing analog temperature display
- Automatic defrost
- Built in heating element below front glass to aid elimination of condensation
- +1°C to +10°C temperature range
- Toughened glass panels
- Illuminated display deck
- 500mm deep white deck
- Switchable static or fan assisted refrigeration
- Climate class 3 (25°C 60% RH)



A15C with optional acrylic rear doors



Optional custom RAL coloured front panels
Stock front panel colour - white

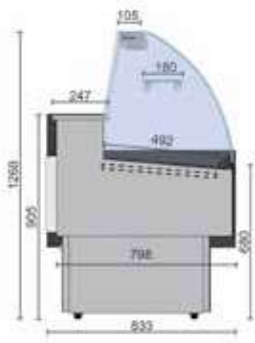

Optional Features

- Custom coloured front panels
- Castor kit
- Till counter
- Acrylic rear doors

MODEL	REAR DOORS	DISPLAY AREA	CAPACITY	WIDTH	DEPTH*	HEIGHT	LIST PRICE
A10C	1	0.61m ²	160 Litres	1000	833	1268	£2420
A15C	1	0.94m ²	249 Litres	1500	833	1268	£2700
A20C	2	1.28m ²	337 Litres	2000	833	1268	£3500
A25C	3	1.62m ²	426 Litres	2500	833	1268	£3850
ACCESSORIES							
CXAR-CX	Till Counter			650	798	905	£1000
PAVAR100VC	Acrylic Rear Doors A10C						£90
PAVAR150VC	Acrylic Rear Doors A15C						£120
PAVAR200VC	Acrylic Rear Doors A20C						£150
PAVAR250VC	Acrylic Rear Doors A25C						£220

*Depth can be reduced to 798mm for installation by removing rear door

FORCED AIR

AUTOMATIC DEFROST

DIGITAL CONTROL

LED ILLUMINATION

Standard Features

- Fresh meat serve over counter
- 0°C to +4°C temperature range
- Large 900mm display deck
- Forced air cooling
- High density polyurethane insulation
- Refrigerated under storage
- Stainless steel display deck
- Stainless steel back shelf
- Acrylic rear doors
- Curved front glass
- Hinged front glass for easy cleaning
- Digital temperature controller
- Digital temperature display
- Interior lighting
- Adjustable feet
- Climate class 3 (25°C 60% RH)

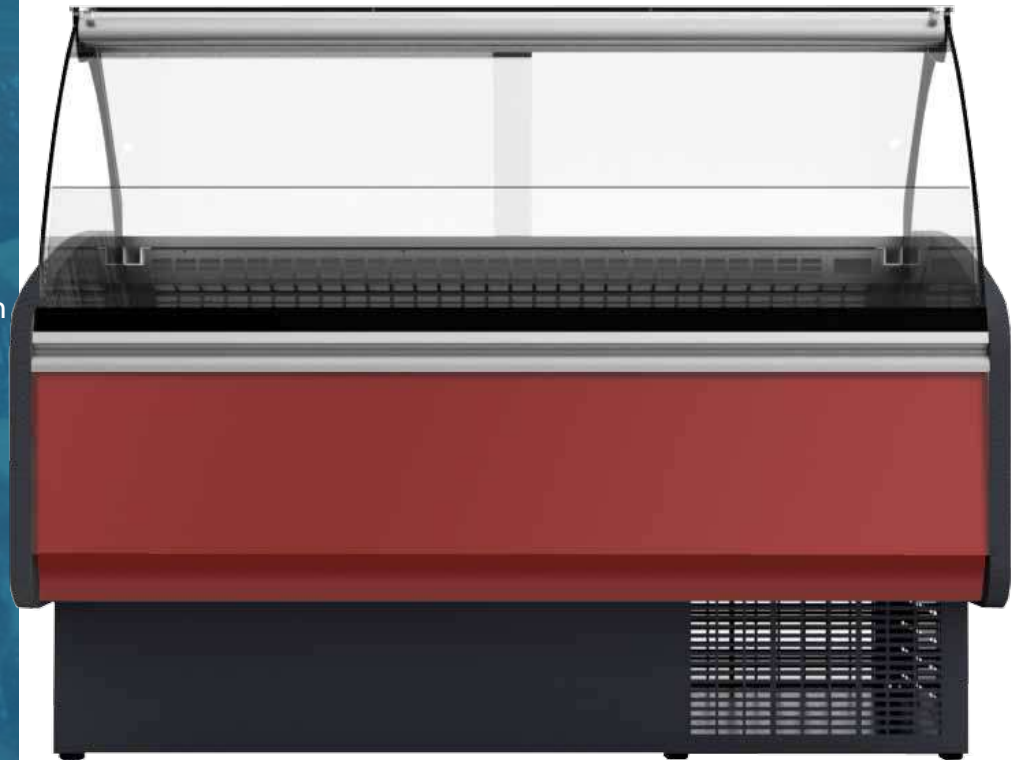

1
YEAR

**PARTS
ONLY**

WARRANTY

SPECIAL ORDER



Java fresh meat serve over counter with 90° external unit & custom coloured front panels

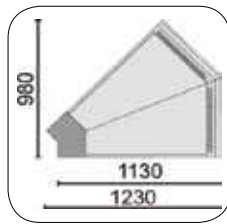
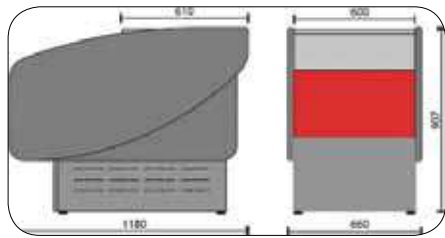
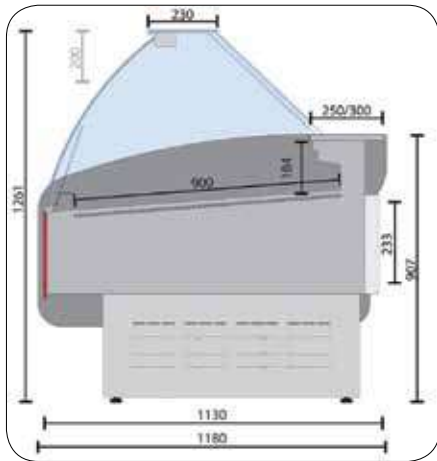

JVE45

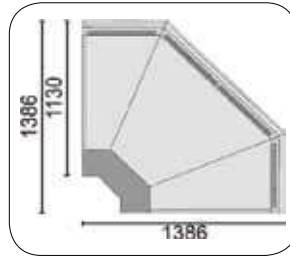

JVE90

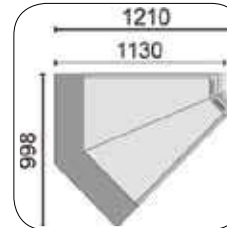

JVI45

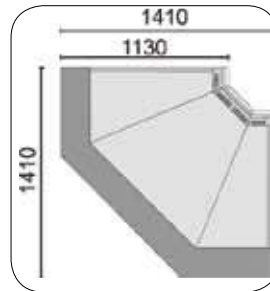

JVI90

Optional Features

- Custom coloured front panels
- Evaporation kit
- Glass dividing panels between multiplexed counters
- Till counter
- Granite back shelf
- Stainless steel base frame
- Intermediate shelf
- LED lighting under front panel
- Multiplexing kit
- Remote cabinets

MODEL	REAR DOORS	DECK SIZE	POWER	WIDTH	DEPTH	HEIGHT	LIST PRICE
JV100	1	0.9m ²	1062w	1060	1150	1261	£4150
JV125	1	1.13m ²	1074w	1310	1150	1261	£4500
JV150	2	1.35m ²	1077w	1560	1150	1261	£4800
JV200	3	1.8m ²	1560w	2060	1150	1261	£5850
JV245	3	2.21m ²	1586w	2510	1150	1261	£6450
JVE45	-	900mm	1054w	980*	1230	1261	£4300
JVE90	-	900mm	1537w	1386*	1386	1261	£5850
JVI45	-	900mm	1018w	998*	1210	1261	£4550
JVI90	-	900mm	1501w	1410*	1410	1261	£6350

ACCESSORIES

ECJ060BL	Till Counter	600*	1180	907	£1050
LDJVLD	Right end panel with glass for serve over	£230			
LEJVLD	Left end panel with glass for serve over	£230			
LDJEC	Right end panel for till counter	£130			
JEJEC	Left end panel for till counter	£130			

*Excludes end panels (add 30mm per side)

**NEW
PRODUCT**

Standard Features

- Constructed entirely from AISI316 stainless steel
- High density polyurethane insulation
- In built 19mm drain outlet
- Available as refrigerated or non refrigerated decks
- Units can be multiplexed to create larger counters



Optional acrylic frontal protection



Optional Scale support

SEE PAGE 26 FOR
ICE FLAKERS

1
YEAR
PARTS
ONLY
WARRANTY



Optional Features

- Acrylic frontal protection
- Scale support
- Multiplexing kit
- Multiplexing decorative panels

MODEL	DECK SIZE	WIDTH	DEPTH	HEIGHT	LIST PRICE
NON REFRIGERATED DECKS					
FISK15	1365 x 950mm	1515	1150	876	£2270
FISK20	1850 x 950mm	2000	1150	876	£2500
FISK25	2350 x 950mm	2500	1150	876	£2800
FISK30	2850 x 950mm	3000	1150	876	£3170
REFRIGERATED DECKS					
FISK15C	1365 x 950mm	1515	1150	876	£2800
FISK20C	1850 x 950mm	2000	1150	876	£3000
FISK25C	2350 x 950mm	2500	1150	876	£3200
FISK30C	2850 x 950mm	3000	1150	876	£3400
ACCESSORIES					
EPSB	Scale Support	400	500	134	£190
EPLIG	Multiplexing Kit				£85
EPDECLIG	Multiplexing Decorative Panel				£125
EP1365	Acrylic Frontal Protection FISK15				£395
EP1850	Acrylic Frontal Protection FISK20				£455
EP2350	Acrylic Frontal Protection FISK25				£505
EP2850	Acrylic Frontal Protection FISK30				£575

FLORIDA
PÂTISSERIE
COUNTERS

Standard Features

- Double glazed front glass (refrigerated models only)
- Double glazed rear doors
- Double glazed side glass
- Forced air cooling
- Automatic defrost and evaporation
- 4 display levels
- Lacquered steel base
- Fully lit interior with LED lighting
- Climate class 3 (25°C / 60% R.H.)
- High density polyurethane insulation
- Front heating element to prevent condensation
- Digital controller
- Digital thermometer
- Automatic evaporation kit as standard
- Adjustable feet





**DESIGN SERVICE
AVAILABLE**

**SEE PAGE 68 FOR
FINISH OPTIONS**

Optional Features

- Custom colour front panels
- Wood effect front panels
- Castors
- Compatible with Corsica counters (see page 44-45)

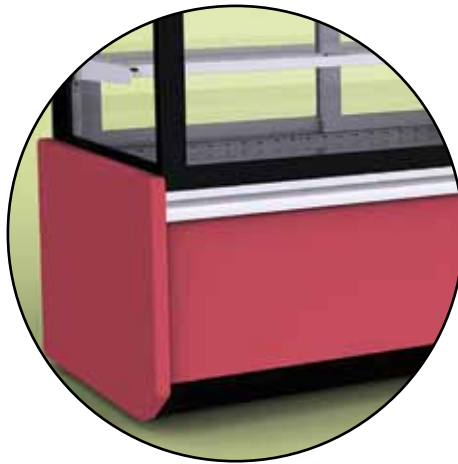

MODEL	DISPLAY AREA	FINISH	TEMPERATURE	WIDTH	DEPTH	HEIGHT	LIST PRICE
F10R	1.5m ²	White	+3°C to +10°C	1000	810	1375	£4500
F14R	1.93m ²	White	+3°C to +10°C	1400	810	1375	£5200
F10A	1.5m ²	White	Ambient	1000	810	1375	£2900
F14A	1.93m ²	White	Ambient	1400	810	1375	£3400
OPTIONS (LEAD TIME MAY APPLY)							
Castor set							£85
RAL coloured lacquered steel front panel							£50
Wood effect front panel with granite or stainless steel plinth							£725

Standard Features

- Double glazed front curved glass (refrigerated and chocolate units)
- Double glazed rear doors (back service units only)
- Double glazed side glass
- 4 display levels
- Lacquered steel base
- Fully lit interior with LED lighting
- High density polyurethane insulation
- Adjustable feet

Refrigerated Cabinets

- Forced air cooling
- Automatic defrost
- Automatic evaporation
- Climate class 3 (25°C / 60% R.H.)
- Front heating element to prevent condensation
- Digital controller and display at rear
- Digital thermometer at front

Chocolate Cabinets

- Humidity control
- Forced air cooling
- Automatic evaporation
- Automatic defrost
- Climate class 3 (25°C / 60% R.H.)
- Front heating element to prevent condensation
- Digital controller and display at rear
- Digital thermometer at front

Heated Cabinets

- Individual temperature control on each shelf
- Halogen heat lamps





CAL10R

**DESIGN SERVICE
AVAILABLE**

**SEE PAGE 68 FOR
FINISH OPTIONS**

Optional Features

- Custom colour front panels
- Wood effect front panels
- Castors
- Compatible with Corsica counters (see page 44-45)

MODEL	DISPLAY AREA	STYLE	TEMPERATURE	WIDTH	DEPTH	HEIGHT	LIST PRICE
CAL10R	1.5m ²	Refrigerated Back Service	+3°C to +10°C	1000	810	1375	£4450
CAL14R	1.93m ²	Refrigerated Back Service	+3°C to +10°C	1400	810	1375	£5050
CAL10A	1.5m ²	Ambient Back Service	Ambient	1000	810	1375	£2900
CAL14A	1.93m ²	Ambient Back Service	Ambient	1400	810	1375	£3450
CAL10H	1.5m ²	Heated Back Service	+75°C to +90°C	1000	810	1375	£3550
CAL14H	1.93m ²	Heated Back Service	+75°C to +90°C	1400	810	1375	£4350
CAL10C	1.5m ²	Chocolate Back Service	+14°C to +16°C	1000	810	1375	£4750
CAL14C	1.93m ²	Chocolate Back Service	+14°C to +16°C	1400	810	1375	£5050
CAL10RO	1.5m ²	Refrigerated Self Service	+3°C to +10°C	1000	810	1375	£4550
CAL10AO	1.5m ²	Ambient Self Service	Ambient	1000	810	1375	£3260
CAL10HO	1.5m ²	Heated Self Service	+75°C to +90°C	1000	810	1375	£3260
OPTIONS (LEAD TIMES MAY APPLY)							
Castor set							£85
RAL coloured lacquered steel front panel							£50
Wood effect front panel with granite or stainless steel plinth							£725

Standard Features

- Modular design
- Granite rear work surface
- CFC free high density polyurethane insulation
- Hydraulic lift up front toughened glass
- Anti-mist frontal heating element
- Easy to clean
- Digital temperature display
- Internal shelves
- Aluminium profiles and glass support super structure in silver anodised finish



Refrigerated Serve Over Counter

- +3°C to +7°C temp. range
- Available in 1m, 1.25m, 1.5m and 2m lengths
- Refrigerated under storage
- 2 shelves + deck

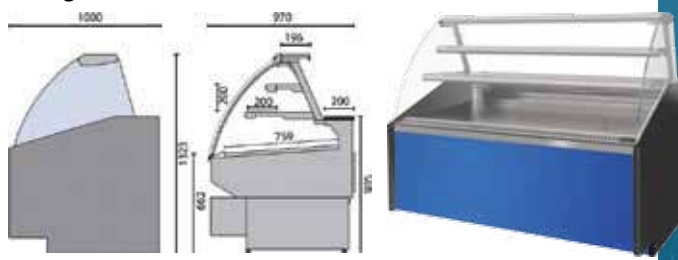

Bakery Counter

- Ambient temperature
- Available in 1m, 1.5m lengths
- 2 shelves + deck

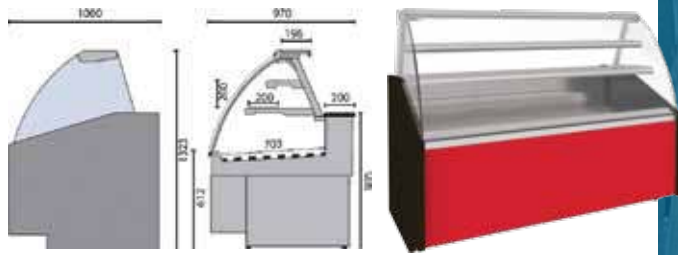

Ambient Counter

- Ambient temperature
- Available in 1m, 1.5m lengths
- Under storage
- 2 shelves + deck

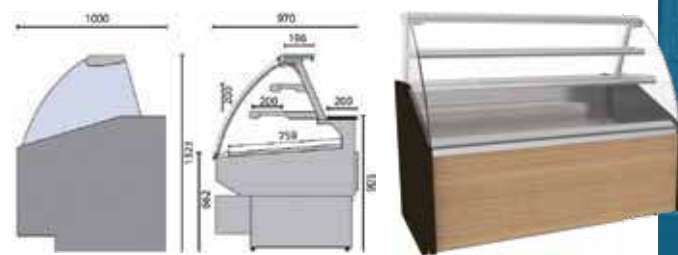

Saladette Counter

- +3°C to +7°C temp. range
- Available in 1m (2 x 1/1GN), 1.25m (3 x 1/1GN) & 1.5m (4 x 1/1GN) lengths
- Under storage
- 1 shelf + deck

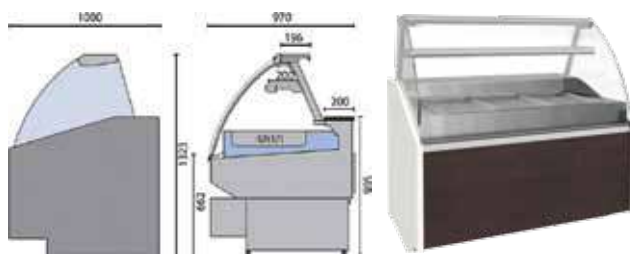

Heated Counter

- +65°C to +75°C temp. range
- Available in 1m, 1.25m & 1.5m lengths
- 1 shelf + deck

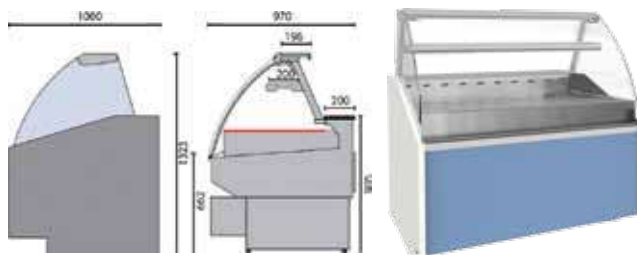

Heated Bain Marie Counter

- +65°C to +75°C temp. range
- Available in 1.25m (3 x 1/1GN) & 1.5m (4 x 1/1GN) lengths
- 1 shelf + deck

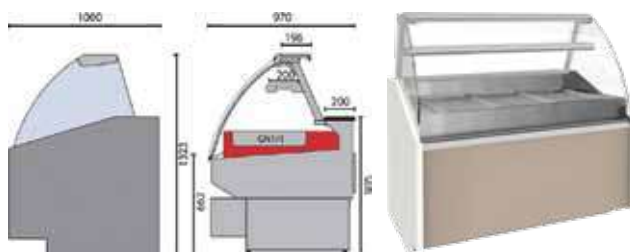

Corner Units

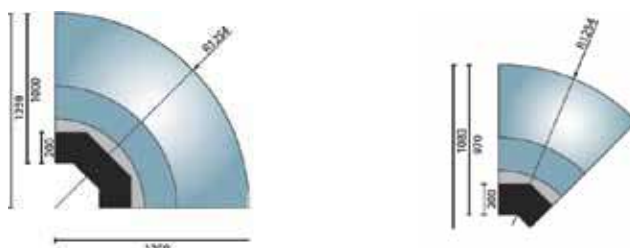

DESIGN SERVICE AVAILABLE

SEE PAGE 68 FOR FINISH OPTIONS

Options

- Sliding acrylic rear doors
- Evaporation kit
- Glass divider
- LED lighting
- Multiplex kits
- Stainless steel work surfaces
- Granite plinths
- Wood finish panels
- Custom coloured RAL panels

SAONA BESPOKE COUNTERS

Standard Features

- Modular design
- Stainless steel rear work surface
- CFC free high density polyurethane insulation
- Hinged front glass
- Anti-mist frontal heating element
- Easy to clean
- Digital temperature display

Base Units

- Refrigerated serve over
- Remote refrigerated serve over
- Chocolate display
- Ambient display
- Bakery display
- Heated display
- Heated bain marie display
- Refrigerated saladette display

Glass Tops

- Curved low glass without shelf
- Curved low glass with shelf
- Curved high glass with high shelf
- Curved high glass with shelf
- Curved high glass with 2 shelves
- Flat low glass without shelf
- Flat low glass with shelf
- Flat high glass with high shelf
- Flat high glass with shelf
- Flat high glass with 2 shelves



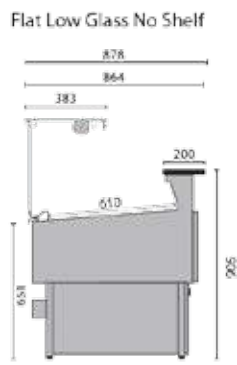
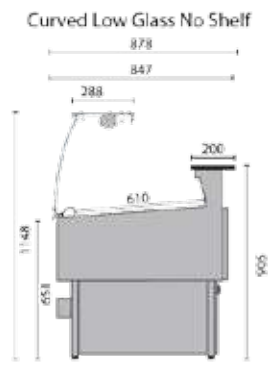

Saona Refrigerated Cabinet
Low Curved Glass
1 Shelf
Basic Decoration

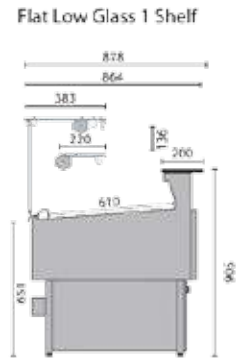
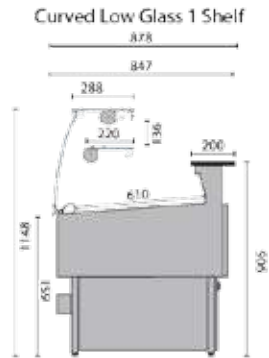

Saona Ambient Cabinet
Low Curved Glass
1 Shelf
Basic Decoration

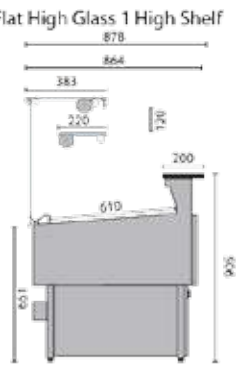
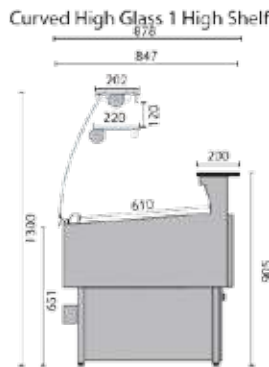

Saona Bain Marie Cabinet
High Flat Glass
1 Shelf
Basic Decoration

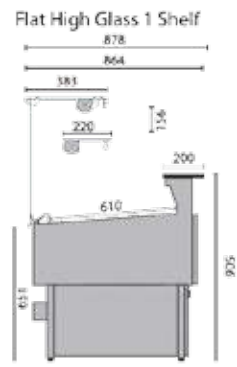
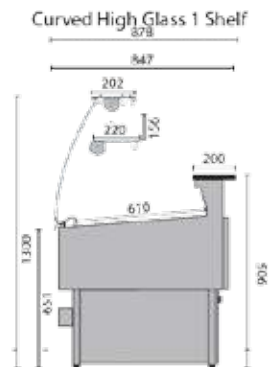

Saona Refrigerated Cabinet
Low Flat Glass
1 Shelf
Wenge Finish

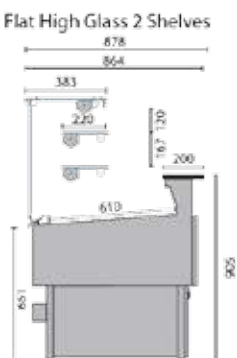
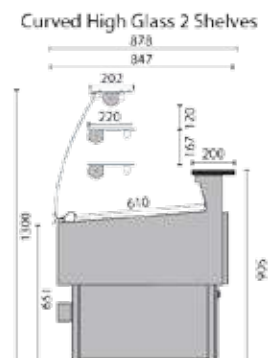

Saona Saladette Cabinet
High Curved Glass
1 Shelf
Basic Decoration

**DESIGN SERVICE
AVAILABLE**

**SEE PAGE 68 FOR
FINISH OPTIONS**

Options

- Sliding acrylic rear doors
- Evaporation kit
- Glass divider
- LED lighting
- Multiplex kits
- Granite work surfaces
- Granite plinths
- Wood finish panels
- Custom coloured RAL panels

CORSICA

BESPOKE COUNTERS

Corsica

Corsica is a bespoke bar and counter solution which can be tailored exactly to suit your needs.

The Corsica range is made from 2 styles of counters. These two simple profiles can be used to create endless possibilities with custom finishes, and internal and external corners to create the perfect counter or bar solution to fit your design and style.

All Corsica counters and bars can be tailored to fit any of our display counters to create a seamless finish

Standard Features

- Modular design
- Stainless steel work surface
- Granite bar tops
- Adjustable feet
- Granite Plinth
- Available as low or high bar cabinets

Options

- 90° internal or external corners
- Coloured finish
- Lacquered finish
- Wooden finish
- Sink tops & taps
- Bottle holders

Compatible With

- Calabria
- Florida
- Nassau
- Saona



Corsica counters with
Lacquered decoration
and Calabria patisserie counters



Corsica counters with
Wenge basic decoration
and Nassau display counters

Corsica High Counters

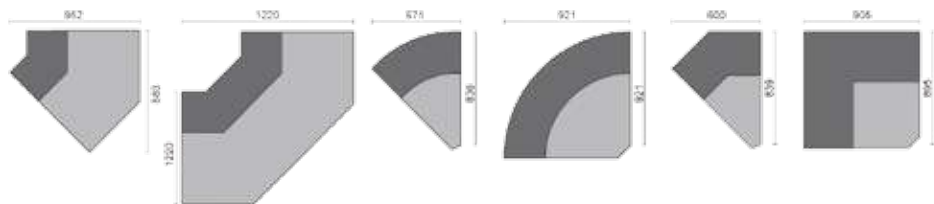
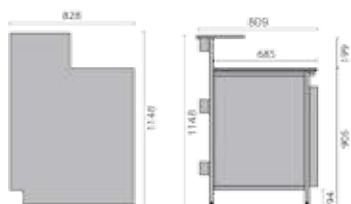

Corsica Low Counters

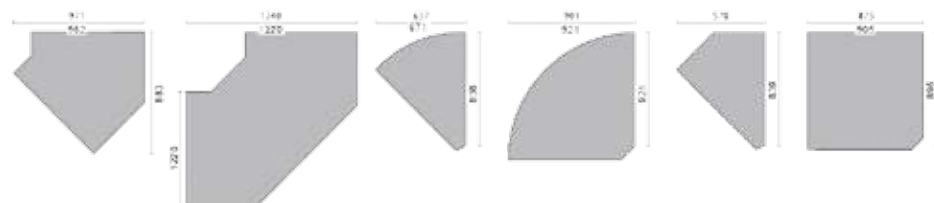

**DESIGN SERVICE
AVAILABLE**

**SEE PAGE 68 FOR
FINISH OPTIONS**



Corsica counters with Wenge basic decoration and Preto impala granite worktops & Saona counters



Corsica counters with Cherry basic decoration and Nassau display counters

Finishes

Custom RAL coloured lacquer, melamine, timber and metal finishes can be applied to our Calabria, Florida, Corsica, Nassau and Saona counter solutions to create the perfect seamless counter run for any installation.

Custom coloured RAL panels can also be specified on our Araya, Aruba and Java cabinets to blend these functional units into any retail outlet.

Plinth and work tops can be supplied in a range of beautiful granite finishes as well as hygienic stainless steel.

A full design service is available on all our counters allowing you to tailor our solutions to your customers needs.

Bars, restaurants, coffee shops, sandwich shops, cafeterias, patisserie, delicatessens, butchers, super markets, convenience stores, our counter ranges have been designed to be adaptable to a multitude of uses.

Examples of Panel Finishes

Lacquered MDF to any RAL colour code



Melamine finishes

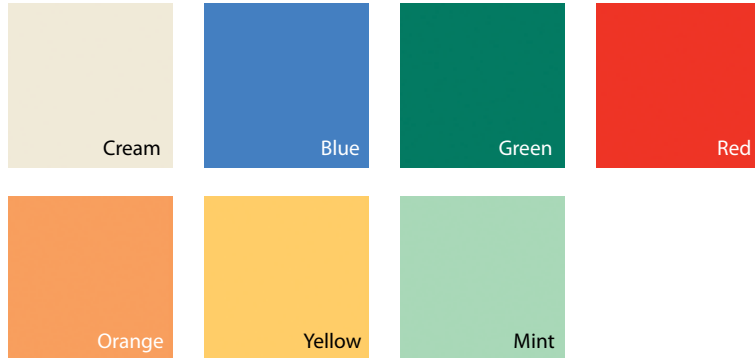

Timber effect finishes

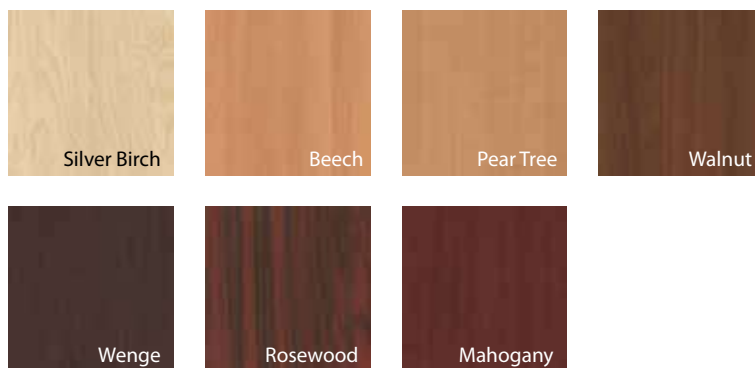

Metal Finishes



Other finishes are available, for a full list of finishes available please contact us

Plinth and Work top Finishes

Standard Granite Finishes



Other finishes are available, for a full list of finishes available please contact us

STORAGE REFRIGERATION

UNDERCOUNTER REFRIGERATION
UPRIGHT REFRIGERATION
COUNTER REFRIGERATION
SALADETTE AND PREP COUNTERS
CHEST FREEZERS
BLAST CHILLERS
COLDROOMS

True
REFRIGERATION®

Prodis

HC SERIES
STORAGE CABINETS

Thanks to years of research and development the HC series offers massive energy savings over its predecessors with up to 47% energy saving on some models.

Hydrocarbon refrigerant has a zero ozone depletion potential and an ultra low global warming potential of <20 making it kind to the environment while saving energy and reducing your carbon footprint

The HC Series is available in 3 sizes in either white or stainless steel finish and is available as either a fridge or a freezer.

All HC series cabinets are fitted with an externally mounted digital temperature controller to ensure a consistent temperature and easy monitoring.

Reversible doors allow the cabinets to be fitted into tight corners or for two cabinets to be fitted side by side and both handles to be conveniently placed centrally.

The full length door handle of the HC series is formed as part of the door and is therefore extremely hard wearing and allows for quick and easy opening of the cabinets.

Security is guaranteed thanks to the built in door lock and maintenance is easy with quick to replace magnetic door gaskets.



HC Series
 Colder by nature



HC SERIES STORAGE CABINETS



FAN ASSISTED COOLING*

AUTOMATIC DEFROST*

DIGITAL CONTROL

LOCKABLE DOOR

REVERSIBLE DOOR

2
YEAR
PARTS
&
LABOUR
WARRANTY

Standard Features

- Stainless steel or white finish
- Lockable door
- External digital temperature control
- Food safe white plastic interior
- Ergonomic full height door handle
- Front venting
- Replaceable door gasket

Fridge Features

- Fan assisted cooling
- Automatic defrost
- Adjustable shelving

Freezer Features

- Static cooling
- Manual defrost
- Static shelving



MODEL	CAPACITY	TEMPERATURE	FINISH	SHELVES	ENERGY RATING	WIDTH	DEPTH	HEIGHT	LIST PRICE
HC201G	200 Litres	+2°C to +8°C	White	2	N/A	598	670	838	£640
HC201R	200 Litres	+2°C to +8°C	White	2	B	598	670	838	£570
HC201F	200 Litres	-23°C to -18°C	White	3	N/A	598	670	838	£620
HC201RSS	200 Litres	+2°C to +8°C	Stainless	2	B	598	670	838	£640
HC201FSS	200 Litres	-23°C to -18°C	Stainless	3	N/A	598	670	838	£680



Prodis

HC Series
Colder by nature

HC SERIES

STORAGE CABINETS



FAN ASSISTED COOLING*

AUTOMATIC DEFROST*

DIGITAL CONTROL

LOCKABLE DOOR

REVERSIBLE DOOR

Standard Features

- Stainless steel or white finish
- Lockable door
- External digital temperature control
- Food safe white plastic interior
- Ergonomic full height door handle
- Front venting
- Replaceable door gasket

Fridge Features

- Fan assisted cooling
- Automatic defrost
- Adjustable shelving

Freezer Features

- Static cooling
- Manual defrost
- Static shelving



2
YEAR
PARTS
&
LABOUR
WARRANTY

MODEL	CAPACITY	TEMPERATURE	FINISH	SHELVES	ENERGY RATING	WIDTH	DEPTH	HEIGHT	LIST PRICE
HC401G	400 Litres	+2°C to +8°C	White	5	N/A	600	693	1875	£930
HC401R	400 Litres	+2°C to +8°C	White	5	D	600	646	1875	£800
HC401F	400 Litres	-23°C to -18°C	White	7	N/A	600	646	1875	£870
HC401RSS	400 Litres	+2°C to +8°C	Stainless	5	D	600	646	1875	£880
HC401FSS	400 Litres	-23°C to -18°C	Stainless	7	N/A	600	646	1875	£960





HC SERIES STORAGE CABINETS

FAN ASSISTED COOLING*

AUTOMATIC DEFROST*

DIGITAL CONTROL

LOCKABLE DOOR

REVERSIBLE DOOR

**2
YEAR
PARTS
&
LABOUR
WARRANTY**

Standard Features

- Stainless steel or white finish
- Lockable door
- External digital temperature control
- Food safe white plastic interior
- Ergonomic full height door handle
- Front venting
- Replaceable door gasket

Fridge Features

- Fan assisted cooling
- Automatic defrost
- Adjustable shelving

Freezer Features

- Static cooling
- Manual defrost
- Static shelving



MODEL	CAPACITY	TEMPERATURE	FINISH	SHELVES	ENERGY RATING	WIDTH	DEPTH	HEIGHT	LIST PRICE
HC601R	600 Litres	+2°C to +10°C	White	4	D	780	720	1895	£990
HC601F	600 Litres	-22°C to -18°C	White	7	N/A	780	720	1895	£1060
HC601RSS	600 Litres	+2°C to +10°C	Stainless	4	D	780	720	1895	£1100
HC601FSS	600 Litres	-22°C to -18°C	Stainless	7	N/A	780	720	1895	£1170



* Applies to fridges only



FORCED AIR

AUTOMATIC DEFROST

DIGITAL CONTROL

LOCKABLE DOOR

LED ILLUMINATION

SELF CLOSING DOOR

Standard Features

- Self closing door
- Top mounted compressor
- Heavy duty full length door handle
- Automatic defrost
- Rounded interior corners
- 2/1GN compatible
- Digital temperature controller
- Mains on/off switch
- Lockable door
- Three shelves per door
- 60mm thick insulation
- Castors fitted as standard
- Full stainless steel construction
- Full adjustable removable shelves

2
YEAR
PARTS
&
LABOUR
WARRANTY





Prodis
GRN Series
Colder by nature
GRN SERIES
SERVICE CABINETS

Thanks to years of research and development the GRN series offers massive energy savings over its predecessors with up to 46% energy saving on some models.

Hydrocarbon refrigerant has a zero ozone depletion potential and an ultra low global warming potential of <20 making it kind to the environment whilst saving energy and reducing your carbon footprint

The GRN Series is available as single and double door units as either a fridge or a freezer.

All GRN series cabinets are fitted with an externally mounted digital temperature controller to ensure a consistent temperature and easy monitoring.

The full length door handle of the GRN series is formed as part of the door and is therefore extremely hard wearing and allows for quick and easy opening of the cabinets.

All units have fan assisted condensers for rapid temperature pull down.



MODEL	CAPACITY	TEMPERATURE	SHELVES	ENERGY RATING	WIDTH	DEPTH	HEIGHT	LIST PRICE
GRN-1R	595 Litres	-2°C to +8°C	3	C	740	830	2010	£1500
GRN-1F	595 Litres	-18° to -22°C	3	D	740	830	2010	£1780
GRN-2R	1325 Litres	-2°C to +8°C	6	C	1480	830	2010	£2510
GRN-2F	1325 Litres	-18° to -22°C	6	D	1480	830	2010	£2710
GRN12GUIDE01			Gastronorm compatible guide set					£50
GNSHELF02			2/1 gastronorm compatible shelf					£60



TGN-SERIES

GASTRONORM
SERVICE CABINETS

FORCED AIR

AUTOMATIC DEFROST

DIGITAL CONTROL

LOCKABLE DOOR

SELF CLOSING DOOR

**NEW
PRODUCT**

Standard Features

- Gastronorm compatible guide sets and shelving
- Dual slide system with anti-tilt wire shelves and 2/1 GN pan storage
- Stainless steel front & door
- Anodized aluminium sides, top & back
- Aluminium interior
- Stainless steel internal floor
- High density insulation
- Oversized refrigeration systems
- Digital temperature control and display
- Internal illumination
- Replaceable door gasket
- Positive seal self closing doors
- Door locks as standard
- R290 hydrocarbon refrigerant

Optional Features

- 102mm standard legs
- 153mm seismic/flanged legs
- 64mm castors
- Additional shelves



WARRANTY 5 YEARS
PARTS, COMPRESSOR AND LABOUR



MODEL	CAPACITY	TEMPERATURE	ENERGY RATING	SHELVES	WIDTH	DEPTH	HEIGHT
TGN-1R-1S	435 Litres	0.5°C to 3.3°C	A	3	729	858	2079
TGN-1F-1S	435 Litres	-18°C to -21°C	C	3	729	858	2079

T-19 SERIES
SERVICE CABINETS

FORCED AIR

AUTOMATIC DEFROST

DIGITAL CONTROL

LOCKABLE DOOR

SELF CLOSING DOOR

**NEW
PRODUCT**



WARRANTY 5 YEARS
PARTS, COMPRESSOR AND LABOUR



Standard Features

- Refrigerators hold 0.5°C to 3.3°C
- Freezers hold -23.3°C
- Stainless steel front & door
- Anodized aluminium sides, top & back
- Aluminium interior
- Stainless steel internal floor
- High density insulation
- High capacity factory balance refrigeration system
- Exterior temperature display
- Internal illumination
- Replaceable door gasket
- Adjustable PVC coated wire shelves
- Positive seal self closing doors
- Lifetime guaranteed door handles
- Door locks as standard
- 64mm swivel castors as standard

MODEL	NET CAPACITY	TEMPERATURE	ENERGY RATING	SHELVES	WIDTH	DEPTH	HEIGHT
T-19-HC	350 Litres	0.5°C to 3.3°C	C	4	686	623	1995
T-19F-HC	350 Litres	-23.3°	D	4	686	623	1995

T-SERIES
SERVICE CABINETS

Standard Features

- Refrigerators hold 0.5°C to 3.3°C
- Freezers hold -23.3°C *
- Stainless steel front
- Anodized aluminium sides, top & back
- Aluminium interior
- Stainless steel internal floor
- High density insulation
- Oversized refrigeration systems
- Exterior temperature display
- Internal illumination (LD models)
- Replaceable door gasket
- Adjustable PVC coated wire shelves
- Positive seal self closing doors
- Lifetime guaranteed door handles
- Door locks as standard
- 64mm swivel castors as standard



T-SERIES
SERVICE CABINETS



FORCED AIR

AUTOMATIC DEFROST

DIGITAL CONTROL

LOCKABLE DOOR

SELF CLOSING DOOR

HC - Hydrocarbon
LD - LED lighting
G - Glass Door
PT - Pass Through
DT - Dual Temperature

MODEL	CAPACITY	TEMPERATURE	ENERGY RATING	SHELVES	WIDTH	DEPTH	HEIGHT
T-23-HC	445 Litres	0.5°C to 3.3°C	C	4	686	750	2074
T-23-2-HC	445 Litres	0.5°C to 3.3°C	C	4	686	750	2074
T-23G-HC~FGD01	445 Litres	0.5°C to 3.3°C	-	4	686	759	2074
T-23G-2-HC~FGD01	445 Litres	0.5°C to 3.3°C	-	4	686	759	2074
T-23PT-HC	459 Litres	0.5°C to 3.3°C	-	4	686	816	2074
T-23F-HC	445 Litres	-23.3°C	D	4	686	750	2074
T-23F-2-HC	445 Litres	-23.3°C	D	4	686	750	2074
T-23DT-HC	368 Litres	Dual Temp.	D	4	687	757	2074
T-35-HC-LD	636 Litres	0.5°C to 3.3°C	E	8	1004	750	2074
T-35G~FGD01	636 Litres	0.5°C to 3.3°C	-	8	1004	759	2074
T-43-HC-LD	756 Litres	0.5°C to 3.3°C	F	8	1194	750	2074
T-43F-HC	738 Litres	-23.3°C	G	8	1194	750	2074
T49-HC-LD	914 Litres	0.5°C to 3.3°C	D	8	1375	750	2074
T49G~FGD01	914 Litres	0.5°C to 3.3°C	-	8	1378	759	2074
T-49F-HC	914 Litres	-23.3°C	D	8	1375	750	2074
T-49F-4-HC	914 Litres	-23.3°C	-	8	1375	750	2074
T-72	1858 Litres	0.5°C to 3.3°C	-	12	1985	750	2074

FORCED AIR

AUTOMATIC DEFROST

DIGITAL CONTROL

SELF CLOSING DOOR

Standard Features

- Self closing door with stay open facility
- 1 x 1/1GN shelf per section
- Automatic defrost
- Rounded interior corners
- Energy efficient Dixell controller
- Heavy duty full length door handle
- Mains on/off switch
- Lockable door
- 60mm thick insulation
- Castors as standard
- Full stainless steel construction
- Fully adjustable removable shelves



GRN-W3



GRN-C2



GRN-C3

SERVICE CABINETS

Thanks to years of research and development the GRN series offers massive energy savings over its predecessors with up to 46% energy saving on some models.

Hydrocarbon refrigerant has a zero ozone depletion potential and an ultra low global warming potential of <20 making it kind to the environment whilst saving energy and reducing your carbon footprint

The GRN Series is available in 2 sizes as either a flat top cabinet or fitted with a 100mm upstand and is available as either a fridge or a freezer.

All GRN series cabinets are fitted with an externally mounted digital temperature controller to ensure a consistent temperature and easy monitoring.

The full length door handle of the GRN series is formed as part of the door and is therefore extremely hard wearing and allows for quick and easy opening of the cabinets.

All units have fan assisted condensers for rapid temperature pull down.



GRN-W2

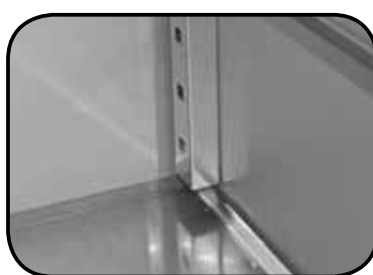
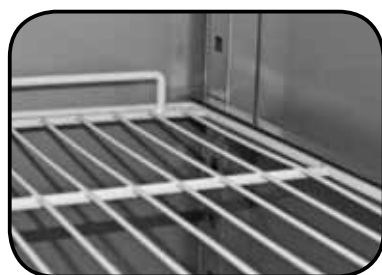

MODEL	CAPACITY	TEMPERATURE	UPSTAND	DOORS	ENERGY RATING	WIDTH	DEPTH	HEIGHT	LIST PRICE
GRN-C2R	283 Litres	-2°C to +8°C	No	2 Solid	B	1360	700	850	£1350
GRN-C2F	283 Litres	-18°C to -22°C	No	2 Solid	D	1360	700	850	£1640
GRN-W2R	283 Litres	-2°C to +8°C	Yes	2 Solid	B	1360	700	950	£1370
GRN-W2F	283 Litres	-18°C to -22°C	Yes	2 Solid	D	1360	700	950	£1660
GRN-C3R	416 Litres	-2°C to +8°C	No	3 Solid	B	1795	700	850	£1550
GRN-C3F	416 Litres	-18°C to -22°C	No	3 Solid	D	1795	700	850	£1860
GRN-W3R	416 Litres	-2°C to +8°C	Yes	3 Solid	B	1795	700	950	£1570
GRN-W3F	416 Litres	-18°C to -22°C	Yes	3 Solid	D	1795	700	950	£1880
GRNECGUIDE01	Gastronorm compatible guide set								£60
GNSHELF01	Gastronorm compatible shelf								£50



TC-SERIES

COUNTER
REFRIGERATION

Standard Features

- Refrigerators hold 0.5°C to 3.3°C
- Freezers hold -23.3°C
- Auto defrost system on freezers
- Stainless steel interior and exterior
- Stainless steel counter top
- Aluminium finished cabinet back
- LED temperature display
- High density polyurethane insulation
- 3 sets of 1/1GN rails per section
- 3 adjustable shelves per section
- Oversized and balanced refrigeration system



WARRANTY 5 YEARS
PARTS, COMPRESSOR AND LABOUR

 natural refrigerant.



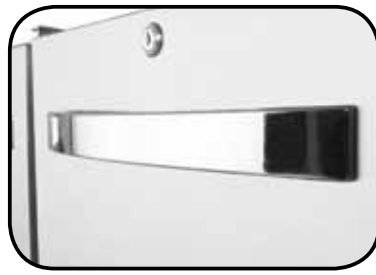

FORCED AIR

AUTOMATIC DEFROST

DIGITAL CONTROL

LOCKABLE DOOR

SELF CLOSING DOOR

Right side refrigeration system

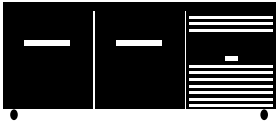

Door 2-Drawer 3-Drawer

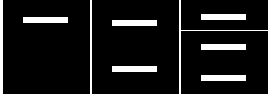

Options

Stainless Steel Top (Standard)
900mm high



Biscuit Top (BI)
840mm high



Work Top (WT)
1000mm high



MODEL	TEMPERATURE	ENERGY RATING	DOORS / DRAWERS	WIDTH	DEPTH	HEIGHT
TCR1/2-CL-BI-2D-2D [†]	0.5°C to 3.3°C	A+	0 / 4	1411	700	840
TCR1/2-CL-BI-3D-3D [†]	0.5°C to 3.3°C	A+	0 / 6	1411	700	840
TCR1/2-CL-BI-DL-DR [†]	0.5°C to 3.3°C	A+	2 / 0	1411	700	840
TCR1/2-CL-SS-2D-2D [†]	0.5°C to 3.3°C	A+	0 / 4	1411	700	900
TCR1/2-CL-SS-3D-3D [†]	0.5°C to 3.3°C	A+	0 / 6	1411	700	900
TCR1/2-CL-SS-DL-DR	0.5°C to 3.3°C	A+	2 / 0	1411	700	900
TCR1/2-CL-WT-2D-2D [†]	0.5°C to 3.3°C	A+	0 / 4	1411	700	1000
TCR1/2-CL-WT-3D-3D [†]	0.5°C to 3.3°C	A+	0 / 6	1411	700	1000
TCR1/2-CL-WT-DL-DR	0.5°C to 3.3°C	A+	2 / 0	1411	700	1000
TCR-1/3-CL-BI-2D-2D-2D [†]	0.5°C to 3.3°C	A+	0 / 6	1865	700	840
TCR1/3-CL-BI-3D-3D-3D [†]	0.5°C to 3.3°C	A+	0 / 9	1865	700	840
TCR1/3-CL-BI-DL-DR-DR [†]	0.5°C to 3.3°C	A+	3 / 0	1865	700	840
TCR1/3-CL-SS-2D-2D-2D [†]	0.5°C to 3.3°C	A+	0 / 6	1865	700	900
TCR1/3-CL-SS-3D-3D-3D [†]	0.5°C to 3.3°C	A+	0 / 9	1865	700	900
TCR1/3-CL-SS-DL-DR-DR	0.5°C to 3.3°C	A+	3 / 0	1865	700	900
TCR1/3-CL-WT-2D-2D-2D [†]	0.5°C to 3.3°C	A+	0 / 6	1865	700	1000
TCR1/3-CL-WT-3D-3D-3D [†]	0.5°C to 3.3°C	A+	0 / 9	1865	700	1000
TCR1/3-CL-WT-DL-DR-DR	0.5°C to 3.3°C	A+	3 / 0	1865	700	1000
TCF1/2-CL-BI-DL-DR [†]	-18°C to -21°C	C	2 / 0	1411	700	840
TCF1/2-CL-SS-DL-DR	-18°C to -21°C	C	2 / 0	1411	700	900
TCF-1/2-CL-WT-DL-DR	-18°C to -21°C	C	2 / 0	1411	700	1000
TCF1/3-CL-BI-DL-DR-DR [†]	-18°C to -21°C	C	3 / 0	1865	700	840
TCF1/3-CL-SS-DL-DR-DR	-18°C to -21°C	C	3 / 0	1865	700	900
TCF1/3-CL-WT-DL-DR-DR	-18°C to -21°C	C	3 / 0	1865	700	1000

CL - Compressor Left
CR - Compressor Right
BI - Biscuit Top
SS - Stainless Steel
WT - Stainless Steel
With Back Splash
2D - 2 Drawer
3D - 3 Drawer
DL - Door Left
DR - Door Right

[†] Extended lead times may apply

SALADETTES

Standard Features

- Full stainless steel construction
- Compact space saving design
- 1 shelf per door
- Under mounted compressor and condenser
- Digital temperature controller
- +2°C to +8°C temperature range
- Full length stainless steel door handles
- Front venting, can be built in
- Adjustable feet
- Rounded internal corners
- Accepts 1/1GN containers
- Fan assisted cooling
- Automatic defrost



2
YEAR
PARTS
&
LABOUR
WARRANTY

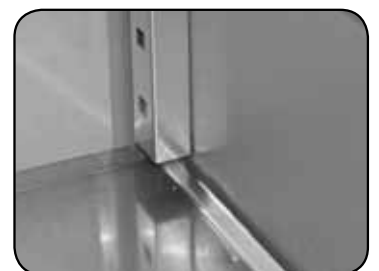

Prodis
 EC Series
 Colder by nature
EC SERIES
 SALADETTES

FAN ASSISTED COOLING

AUTOMATIC DEFROST

DIGITAL CONTROL



2
YEAR
PARTS
&
LABOUR
WARRANTY

MODEL	CAPACITY	TEMPERATURE	SHELVES	DOORS/DRAWERS	ENERGY RATING	WIDTH	DEPTH	HEIGHT	LIST PRICE
EC-2SS	240 Litres	+2°C to +8°C	2	2 Doors	C	903	700	870	£980
EC-3SS	368 Litres	+2°C to +8°C	3	3 Doors	C	1365	700	870	£1170
EC-4DSS	240 Litres	+2°C to +8°C	-	4 Drawers	C	903	700	870	£1480
EC-6DSS	368 Litres	+2°C to +8°C	-	6 Drawers	C	1365	700	870	£2210
GRNECGUIDE01				Gastronorm compatible guide set					£60
GNSHELF01				Gastronorm compatible shelf					£50



FAN ASSISTED COOLING

AUTOMATIC DEFROST

DIGITAL CONTROL

Standard Features

- Full stainless steel construction
- Compact space saving design
- Under mounted compressor and condenser
- Refrigerated prep section
- Accepts 1/6GN pans in topping unit*
- Digital temperature controller
- +2°C to +8°C temperature range
- Full length stainless steel door handles
- Front venting, can be built in
- Adjustable feet
- Rounded internal corners
- Accepts 1/1GN containers in refrigerator
- 1 x shelf per door
- Fan assisted cooling
- Automatic defrost

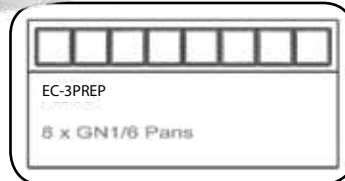
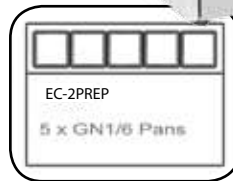

2
YEAR
PARTS
&
LABOUR
WARRANTY



MODEL	CAPACITY	TOP CAPACITY	SHELVES	DOORS	WIDTH	DEPTH	HEIGHT	LIST PRICE
EC-2PREP	240 Litres	5 x 1/6GN	2	2	903	700	1006	£1140
EC-3PREP	410 Litres	8 x 1/6GN	3	3	1365	700	1006	£1560
GRNECGUIDE01			Gastronorm compatible guide set					£60
GNSHELF01			Gastronorm compatible shelf					£50

*Pans not supplied



FAN ASSISTED COOLING

AUTOMATIC DEFROST

DIGITAL CONTROL

Standard Features

- Full stainless steel construction
- Compact space saving design
- Under mounted compressor and condenser
- Refrigerated prep section
- Accepts 1/1GN pans in top*
- Digital temperature controller
- +2°C to +8°C temperature range
- Full length stainless steel door handles
- Front venting, can be built in
- Adjustable feet
- Rounded internal corners
- Accepts 1/1GN containers in refrigerator
- 1 x shelf per door
- Fan assisted cooling
- Automatic defrost

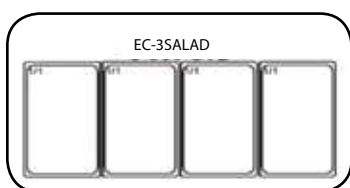
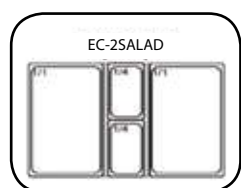

MODEL	CAPACITY	TOP CAPACITY*	SHELVES	DOORS	WIDTH	DEPTH	HEIGHT	LIST PRICE
EC-2SALAD	240 Litres	2 x 1/1 + 2 x 1/4GN	2	2	903	700	882	£860
EC-3SALAD	410 Litres	4 x 1/1GN	3	3	1365	700	882	£1140
GRNECGUIDE01		Gastronorm compatible guide set						£60
GNSHELF01		Gastronorm compatible shelf						£50



*Pans not supplied

True® REFRIGERATION TSSU-SERIES SALAD PREP UNITS



FORCED AIR

AUTOMATIC DEFROST

SELF CLOSING DOOR

DIGITAL CONTROL

Standard Features

- Holds 0.5°C to 5.0°C
- 360° airflow for uniform cooling
- 102mm deep, clear poly carbonate pans (supplied)
- Extra deep full length cutting board
- Stainless steel foam insulated lid
- Removable back hood and lid
- Stainless steel construction
- Aluminium finished back
- Adjustable PVC coated wire shelves
- Oversized and balanced refrigeration system

WARRANTY 5 YEARS
PARTS, COMPRESSOR AND LABOUR



MODEL	CAPACITY	DOORS / DRAWERS	TOP PANS	WIDTH	DEPTH	HEIGHT
TSSU-27-08-HC	184 Litres	1 / 0	8 x 1/6GN	702	766	1093
TSSU-27-08D-2-HC	184 Litres	0 / 2	8 x 1/6GN	702	766	1093
TSSU-36-08-HC	240 Litres	2 / 0	8 x 1/6GN	924	766	1093
TSSU-48-08-HC	366 Litres	2 / 0	8 x 1/6GN	1229	766	1093
TSSU-48-10-HC	366 Litres	2 / 0	10 x 1/6GN	1229	766	1093
TSSU-48-12-HC	396 Litres	2 / 0	12 x 1/6GN	1229	766	1093
TSSU-48-12D-2-HC	366 Litres	1 / 2	12 x 1/6GN	1229	766	1093
TSSU-48-12D-4-HC	366 Litres	0 / 4	12 x 1/6GN	1229	766	1093
TSSU-60-08-HC	439 Litres	2 / 0	8 x 1/6GN	1534	766	1093
TSSU-60-10-HC	439 Litres	2 / 0	10 x 1/6GN	1534	766	1093
TSSU-60-12-HC	439 Litres	2 / 0	12 x 1/6GN	1534	766	1093
TSSU-60-16-HC	439 Litres	2 / 0	16 x 1/6GN	1534	766	1093
TSSU-60-16-DS-ST-HC	439 Litres	2 / 0	16 x 1/6GN	1534	766	1093
TSSU-60-16D-2-HC	439 Litres	2 / 0	16 x 1/6GN	1534	766	1093
TSSU-60-16D-4-HC	439 Litres	0 / 4	16 x 1/6GN	1534	766	1093
TSSU-72-08	439 Litres	3 / 0	8 x 1/6GN	1839	766	1093
TSSU-72-10	439 Litres	3 / 0	10 x 1/6GN	1839	766	1093
TSSU-72-12	439 Litres	3 / 0	12 x 1/6GN	1839	766	1093
TSSU-72-16	439 Litres	3 / 0	16 x 1/6GN	1839	766	1093
TSSU-72-18	538 Litres	3 / 0	18 x 1/6GN	1839	766	1093

D - Drawered
HC - Hydrocarbon
DS - Dual Sided
ST - Split Top

TSSU-SERIES
SALAD PREP UNITS
MEGA-TOP



FORCED AIR

AUTOMATIC DEFROST

DIGITAL CONTROL

SELF CLOSING DOOR

Standard Features

- Holds 0.5°C to 5.0°C
- 360° airflow for uniform cooling
- 102mm deep, clear poly carbonate pans (supplied)
- Extra deep full length cutting board
- Hinged glass lid
- Stainless steel construction
- Aluminium finished back
- Adjustable PVC coated wire shelves
- Oversized and balanced refrigeration system

M-B / M-C - Mega-top
HC - Hydrocarbon
DS - Dual Sided
ST - Split Top

WARRANTY 5 YEARS
PARTS, COMPRESSOR AND LABOUR



MODEL	CAPACITY	DOORS / DRAWERS	TOP PANS	WIDTH	DEPTH	HEIGHT
TSSU-27-12M-C-HC	184 Litres	1 / 0	12 x 1/6GN	702	867	1185
TSSU-36-12M-B-HC	240 Litres	2 / 0	12 x 1/6GN	924	867	1185
TSSU-48-12M-B-HC	340 Litres	2 / 0	12 x 1/6GN	1229	867	1185
TSSU-48-18M-B-HC	366 Litres	2 / 0	18 x 1/6GN	1229	867	1185
TSSU-60-12M-B-HC	439 Litres	2 / 0	12 x 1/6GN	1534	867	1185
TSSU-60-15M-B-HC	439 Litres	2 / 0	15 x 1/6GN	1534	867	1185
TSSU-60-18M-B-HC	439 Litres	2 / 0	18 x 1/6GN	1534	867	1185
TSSU-60-24M-B-ST-HC	439 Litres	2 / 0	24 x 1/6GN	1534	867	1185
TSSU-60-24M-B-DS-ST-HC	439 Litres	2 / 0	24 x 1/6GN	1534	1026	956
TSSU-72-12M-B	538 Litres	3 / 0	12 x 1/6GN	1839	867	1185
TSSU-72-15M-B	538 Litres	3 / 0	15 x 1/6GN	1839	867	1185
TSSU-72-18M-B	538 Litres	3 / 0	18 x 1/6GN	1839	867	1185
TSSU-72-24M-B-ST	538 Litres	3 / 0	24 x 1/6GN	1839	867	1185
TSSU-72-30M-B-ST	538 Litres	3 / 0	30 x 1/6GN	1839	867	1185
TSSU-72-30M-B-DS-ST	538 Litres	3 / 0	30 x 1/6GN	1839	1064	956

True
REFRIGERATION
TSSU-SERIES
SALAD PREP UNITS
GLASS-TOP

FORCED AIR

AUTOMATIC DEFROST

SELF CLOSING DOOR

DIGITAL CONTROL



Standard Features

- Holds 0.5°C to 5.0°C
- 360° airflow for uniform cooling
- 102mm deep, clear poly carbonate pans (supplied)
- Extra deep full length cutting board
- Hinged glass lid
- Stainless steel construction
- Aluminium finished back
- Adjustable PVC coated wire shelves
- Oversized and balanced refrigeration system

WARRANTY 5 YEARS
PARTS, COMPRESSOR AND LABOUR



MODEL	CAPACITY	TEMPERATURE	TOP PANS	DOORS	WIDTH	DEPTH	HEIGHT
TSSU-48-18M-B-FGLID-HC	340 Litres	+0.5°C to +5°C	18 x 1/6GN	2	1229	884	967 / 1552
TSSU-60-24M-B-ST-FGLID-HC	439 Litres	+0.5°C to +5°C	24 x 1/6GN	2	1532	884	967 / 1552
TSSU-72-30M-B-ST-FGLID	538 Litres	+0.5°C to +5°C	30 x 1/6GN	3	1839	884	967 / 1552

True
REFRIGERATION
TFP-SERIES
FOOD PREP UNITS

FORCED AIR

AUTOMATIC DEFROST

DIGITAL CONTROL

SELF CLOSING DOOR



Standard Features

- Holds 0.5°C to 5.0°C
- 360° airflow for uniform cooling
- 102mm deep, clear poly carbonate pans (supplied)
- Extra deep full length cutting board
- Stainless steel foam insulated lid
- Removable back hood and lid
- Stainless steel construction
- Aluminium finished back
- Adjustable PVC coated wire shelves
- Oversized and balanced refrigeration system

WARRANTY 5 YEARS
PARTS, COMPRESSOR AND LABOUR



MODEL	CAPACITY	TEMPERATURE	TOP PANS	DOORS / DRAWERS	WIDTH	DEPTH	HEIGHT
TFP-32-12M-HC	314 Litres	+0.5°C to +5°C	12 x 1/6GN	1 / 0	816	801	1181
TFP-32-12M-D-2-HC	314 Litres	+0.5°C to +5°C	12 x 1/6GN	0 / 2	816	801	1181
TFP-48-18M-HC	501 Litres	+0.5°C to +5°C	18 x 1/6GN	2 / 0	1223	801	1181
TFP-48-18M-D-2-HC	501 Litres	+0.5°C to +5°C	18 x 1/6GN	1 / 2	1223	801	1181
TFP-48-18M-D-4-HC	501 Litres	+0.5°C to +5°C	18 x 1/6GN	0 / 4	1223	801	1181

True
REFRIGERATION
TPP-SERIES
PIZZA PREP UNITS



FORCED AIR

AUTOMATIC DEFROST

SELF CLOSING DOOR

DIGITAL CONTROL

Standard Features

- Holds 0.5°C to 5.0°C
- 360° airflow for uniform cooling
- 150mm deep poly carbonate pans (supplied)
- Extra deep full length removable cutting board
- Hinged insulated cover
- Aluminium finished back
- All stainless front, top and sides
- Adjustable PVC coated wire shelves
- Heavy duty recessed door handles
- Oversized and balanced refrigeration system



WARRANTY 5 YEARS
PARTS, COMPRESSOR AND LABOUR



AT - Angled Top
HC - Hydrocarbon
D - Drawered

MODEL	DOOR / DRAWERS	TOP PANS	CAPACITY	WIDTH	DEPTH	HEIGHT
TPP-AT-44-HC	1 / 0	6 x 1/3GN	323 Litres	1131	854	1058
TPP-AT-44D-2-HC	0 / 2	6 x 1/3GN	323 Litres	1131	854	1058
TPP-AT-60-HC	2 / 0	8 x 1/3GN	451 Litres	1531	854	1058
TPP-AT-60D-2-HC	1 / 2	8 x 1/3GN	451 Litres	1531	854	1058
TPP-AT-67-HC	2 / 0	9 x 1/3GN	671 Litres	1709	854	1058
TPP-AT-67D-2-HC	1 / 2	9 x 1/3GN	671 Litres	1709	854	1058
TPP-AT-67D-4-HC	0 / 4	9 x 1/3GN	671 Litres	1709	854	1058
TPP-AT-93-HC	3 / 0	12 x 1/3GN	1011 Litres	2369	854	1058
TPP-AT-93D-2-HC	2 / 2	12 x 1/3GN	1011 Litres	2369	854	1058
TPP-AT-93D-4-HC	1 / 4	12 x 1/3GN	1011 Litres	2369	854	1058
TPP-AT-93D-6-HC	0 / 6	12 x 1/3GN	1011 Litres	2369	854	1058
TPP-AT-119-HC	4 / 0	15 x 1/3GN	1328 Litres	3029	854	1058
TPP-AT-119D-2-HC	3 / 2	15 x 1/3GN	1328 Litres	3029	854	1058
TPP-AT-119D-4-HC	2 / 4	15 x 1/3GN	1328 Litres	3029	854	1058
TPP-AT-119D-6-HC	1 / 6	15 x 1/3GN	1328 Litres	3029	854	1058
TPP-AT-119D-8-HC	0 / 8	15 x 1/3GN	1328 Litres	3029	854	1058

FAN ASSISTED COOLING

AUTOMATIC DEFROST

DIGITAL CONTROL



2
YEAR
PARTS
&
LABOUR
WARRANTY

Standard Features

- Full stainless steel construction
- Compact space saving design
- Under mounted compressor and condenser
- Separate refrigerated prep top
- Topping unit accepts 6 x 1/4GN pans (not supplied)
- Granite work top
- Front venting, can be built in
- Adjustable feet
- Rounded internal corners for easy cleaning
- Accepts 1/1GN containers in refrigerator
- Automatic defrost
- Unit requires 2 x 13 amp connections

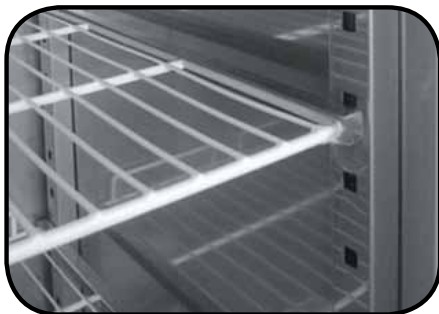

Gastronorm Compatible Shelving



Rounded Internal Corners



Heavy Duty Door Handles



Replaceable Door Gaskets

MODEL	CAPACITY	TEMPERATURE	TOP PANS	WIDTH	DEPTH	HEIGHT	LIST PRICE
EC-3PIZZA	368 Litres	+2°C to +8°C	6 x 1/4	1400	700	1455	£1900
GRNECGUIDE01			Gastronorm compatible guide set				£60
GNSHELF01			Gastronorm compatible shelf				£50



FORCED AIR

AUTOMATIC DEFROST

Standard Features

- Holds 0.5°C to 3.3°C
- Stainless steel front top and sides
- Aluminium interior
- Stainless steel floor
- Heavy duty one piece stainless steel top with "V" edge to protect against spills
- One section counter top supports up to 325kg of equipment
- Two section counter top supports up to 491kg of equipment
- Gastronorm compatible drawers
- Heavy-duty stainless steel drawer slides and rollers. Removable without tools for easy cleaning.
- Oversized and balanced refrigeration system



Installation of a heat shield is recommended for optimum performance (supplied by others)
Minimum clearance of 102mm required between cooking equipment and TRCB top

MODEL	CAPACITY	DRAWERS	CAPACITY PER DRAWER	WIDTH	DEPTH	HEIGHT
TRCB-36	167 Litres	2	1 x 1/1GN, 3 x 1/6GN	924	816	645
TRCB-52	280 Litres	2	3 x 1/1GN	1318	816	645
TRCB-52-60	280 Litres	2	3 x 1/1GN	1524	816	645
TRCB-72	425 Litres	4	2 x 1/1GN	1839	816	645
TRCB-96	589 Litres	4	3 x 1/1GN	2426	816	645
TRCB-110	623 Litres	6	2 x 1/1GN	2794	775	645



Standard Features

- Stainless steel interior & exterior
- Available with curved glass top or stainless steel lid
- Designed for 1/3 GN pans
- Digital temperature controller
- Manual defrost
- Digital temperature display

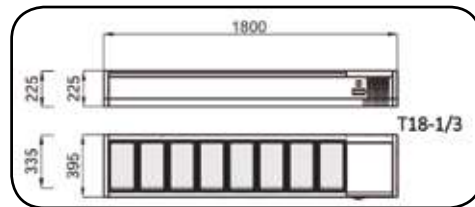
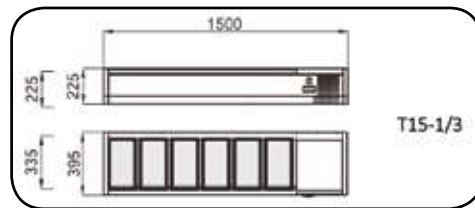
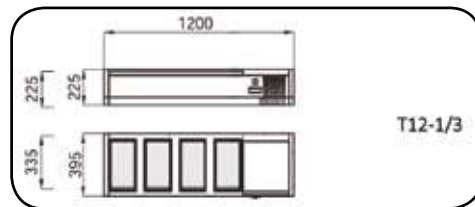

MODEL	LID STYLE	PAN CAPACITY	TEMPERATURE	WIDTH	DEPTH	HEIGHT	LIST PRICE
EC-T12G	Glass	4 x 1/3GN	+2°C to +8°C	1200	395	435	£700
EC-T15G	Glass	6 x 1/3GN	+2°C to +8°C	1500	395	435	£780
EC-T18G	Glass	8 x 1/3GN	+2°C to +8°C	1800	395	435	£850
EC-T12S	Stainless	4 x 1/3GN	+2°C to +8°C	1200	395	435	£630
EC-T15S	Stainless	6 x 1/3GN	+2°C to +8°C	1500	395	435	£700
EC-T18S	Stainless	8 x 1/3GN	+2°C to +8°C	1800	395	435	£760



STATIC COOLING

LOCKABLE LID

FULL SET OF BASKETS

FIVE YEAR WARRANTY

Standard Features

- Includes full set of baskets
- Aluminium interior
- LCD temperature display
- Counter balanced lid
- 60mm thick insulation
- Lockable lid
- Galvanised steel construction
- Optional fully welded stainless steel lid
- -18°C to -22°C temperature range
- Hydrocarbon refrigerant
- Energy efficient design



AR350SS



AR450SS



AR550SS



AR650W

ARCTIC SERIES CHEST FREEZERS



5 YEAR
5
PARTS & LABOUR WARRANTY

5 YEAR FULL ON SITE WARRANTY

INCLUDES FULL SET OF BASKETS



MODEL	LID	CAPACITY	BASKETS	WIDTH	DEPTH	HEIGHT	LIST PRICE
AR350W	White	350 Litres	3	1030	750	850	£590
AR350SS	Stainless	350 Litres	3	1030	750	850	£680
AR450W	White	450 Litres	3	1270	750	850	£690
AR450SS	Stainless	450 Litres	3	1270	750	850	£800
AR550W	White	550 Litres	4	1530	750	850	£820
AR550SS	Stainless	550 Litres	4	1530	750	850	£990
AR650W	White	650 Litres	4	1800	750	850	£970
AR650SS	Stainless	650 Litres	4	1800	750	850	£1140





Standard Features

- High quality AISI304 18/10 stainless steel construction
- Rounded interior corners for easy cleaning
- Cataphoresis coated anti-corrosion evaporators to ensure high reliability
- Special fans suitable for low temperature operation
- High performance refrigeration units made in Italy
- R452a refrigerant
- Ergonomic controller for ease of use
- High density insulation for high efficiency
- Soft and hard cycles for both blast chilling and deep freezing
- Time or temperature deep freezing
- Core probe as standard
- Automatic or manual defrost
- Counter top, under counter or free standing models available
- 10 models across the range
- All models 1/1GN compatible
- MXT5 & upwards EN 60x40 compatible



MX3.10C 3 TRAYS COMPACT-SIZED

GN 1/1 - GN 2/3

Counter blast chiller - deep freezer
Suitable for small restaurants.
Small and highly professional

CAPACITY

3 GN 1/1 - 2/3
(+90°C/+3°C):10kg
(+90°C/-18°C):5kg



MX5.12C 5 TRAYS COMPACT-SIZED

GN 1/1 - GN 2/3

Counter blast chiller - deep freezer
Suitable for restaurants up to 50 covers
Super versatile

CAPACITY

5 GN 1/1 - 2/3
(+90°C/+3°C):12kg
(+90°C/-18°C):7kg



MX5.12ST 5 TRAYS UNDER COUNTER

GN 1/1 - GN 2/3

Under counter blast chiller - deep freezer
with frontal airflow, suitable for tight
spaces

CAPACITY

5 GN 1/1 - 2/3
(+90°C/+3°C):12kg
(+90°C/-18°C):7kg



MXT5.15 5 TRAYS ENTRY LEVEL

GN 1/1 - EN 60x40

Counter-height blast chiller - deep freezer
suitable for both restaurants and patisserie

CAPACITY

5 GN 1/1 - EN 60 x 40
(+90°C/+3°C):15kg
(+90°C/-18°C):9kg



MXT5.20 5 TRAYS COUNTER-HEIGHT

GN 1/1 - EN 60 x 40

Counter-height blast chiller - deep freezer
suitable for oven overlap. Recommended
for patisserie, restaurant and catering.

CAPACITY

5 GN 1/1 - EN 60 x 40
(+90°C/+3°C):20kg
(+90°C/-18°C):12kg



MXT5.30 5 TRAYS COUNTER-HEIGHT

GN 1/1 - EN 60 x 40

Counter-height blast chiller - deep freezer suitable for oven overlap. High performance version, recommended for food processing and ice cream manufacture.

CAPACITY

5 GN 1/1 - EN 60 x 40
(+90°C/+3°C):30kg
(+90°C/-18°C):18kg



MXT7.20 7 TRAYS WITH WORK TOP

GN 1/1 - EN 60 x 40

Blast chiller - deep freezer with load bearing work top, 1000mm height Recommended for patisserie, restaurant and catering.

CAPACITY

7 GN 1/1 - EN 60 x 40
(+90°C/+3°C):20kg
(+90°C/-18°C):12kg



MXT7.30 7 TRAYS WITH WORK TOP

GN 1/1 - EN 60 x 40

Blast chiller - deep freezer with load bearing work top, 1000mm height. High performance version, recommended for food processing and ice cream manufacture.

CAPACITY

7 GN 1/1 - EN 60 x 40
(+90°C/+3°C):30kg
(+90°C/-18°C):18kg



MXT10.35 10 TRAYS FULL SIZE

GN 1/1 - EN 60 x 40

Plug in blast chiller - deep freezer suitable for medium capacity production

CAPACITY

10 GN 1/1 - EN 60 x 40
(+90°C/+3°C):35kg
(+90°C/-18°C):20kg



MXT14.40 14 TRAYS HIGH CAPACITY

GN 1/1 - EN 60 x 40

High capacity blast chiller - deep freezer.

Large capacity suitable for medium-high production.

CAPACITY

14 GN 1/1 - EN 60 x 40
(+90°C/+3°C):40kg
(+90°C/-18°C):25kg

Prodis

MX SERIES BLAST CHILLERS



SINCOLD

NEW PRODUCT



Standard Features

- High quality AISI304 18/10 stainless steel construction
- Rounded interior corners for easy cleaning
- Cataphoresis coated anti-corrosion evaporators to ensure high reliability
- Special fans suitable for low temperature operation
- High performance refrigeration units made in Italy
- Ergonomic controller for ease of use
- High density insulation for high efficiency
- Soft and hard cycles for both blast chilling and deep freezing
- Time or temperature deep freezing
- Core probe as standard
- Automatic or manual defrost
- Counter top, under counter or free standing models available
- 10 models across the range
- All models 1/1GN compatible
- MXT5 & upwards EN 60x40 compatible

PERFORMANCE

- Easy & quick maintenance
- High quality AISI304 18/10 stainless steel
- Inner rounded angles, curved bottoms and water drain for easy cleaning

INSIDE

CATAPHORESIS COATED ANTI-CORROSION EVAPORATORS TO ENSURE HIGH RELIABILITY

SPECIAL FANS SUITABLE FOR LOW TEMPERATURE OPERATION



HIGH DENSITY INSULATION FOR HIGH EFFICIENCY

ERGONOMIC CONTROLLER FOR EASE OF USE

CONDENSING UNIT CAN BE ACCESSED WITHOUT TOOLS FOR EASY MAINTENANCE

HIGH PERFORMANCE REFRIGERATION UNITS MADE IN ITALY

With the new intuitive digital controller for easy control of the whole production, the MX blast chiller raises the professional standards of your team, maximises the performance and rationalizes time and management costs.

MANUAL AND/OR AUTOMATIC DEFROST START AND STOP



TIME OR TEMPERATURE BLAST CHILLING +3°C WITH CORE PROBE OR TIME CYCLE + AUTOMATIC CONSERVATION STAGE,

TIME OR TEMPERATURE DEEP FREEZING -18°C WITH CORE PROBE + AUTOMATIC

SOFT AND HARD CYCLES FOR BOTH BLAST CHILLING +3°C OR DEEP FREEZING -18°C



BAKERY



- Efficient and quick deep freezing -18°C
- Respects the organoleptic qualities of food and yeasts
- **HARD** function for both blast-chilling and deep-freezing for thick dough or biga starter



PATISSERIE



- End of cycle set point able to be customised
- Avoids the formation of humidity for high quality results
- Full respect of the most delicate food thanks to the **SOFT** function for both blast chilling +3°C and deep freezing -18°C

CATERING



- Automatic control on core probe insertion
- No weight and volume loss
- Reliability on performance stated
- Raw fish sanitisation cycle
- Ideal to cool down vacuum packed food

ICE-CREAM



- High performance for low temperature uses
- Rapid temperature descent from -20°C to -30°C within 10 minutes (ice cream models only)
- Pre-cooling cycle

Prodis

MX SERIES BLAST CHILLERS



SINCOLD

**NEW
PRODUCT**

**2
YEAR
PARTS
ONLY
WARRANTY**

MODEL	+90°C TO 3°C	+90°C TO -18°C	POWER	WIDTH	DEPTH	HEIGHT	LIST PRICE
MX3.10C	10kg	5kg	13amp	655	715	510/530	£3190
MX5.12C	12kg	7kg	13amp	655	715	685/715	£3760
MX5.12ST	12kg	7kg	13amp	655	710	755/785	£3900
MXT5.15	15kg	9kg	13amp	798	700	835/865	£4730
MXT5.20	20kg	12kg	13amp	798	700	835/865	£4980
MXT5.30	30kg	18kg	13amp	798	700	835/865	£5550
MXT7.20	20kg	12kg	13amp	798	815	995/1025	£5730
MXT7.30	30kg	18kg	13amp	798	815	995/1025	£6030
MXT10.35	35kg	20kg	13amp	798	808	1500/1540	£6960
MXT14.40	40kg	25kg	3 phase	798	808	1810/1850	£8530

Prodis

ISARK
COLD ROOMS





Standard Features

- Complete modular cold room
- Straddle style mono bloc
- Quick and easy to assemble
- 85mm thick insulation
- Heavy duty door handles
- Lockable door
- Pressure release valve (freezers)
- Door heaters (freezers)
- Available in over 150 sizes between 2m³ to 20m³ from stock
- Phenolic resin floor

Options

- 2.4m high room
- Chiller room without floor
- Remote split refrigeration
- Bulkhead lighting
- PVC strip curtain
- Aluminium racking

The Isark cold room is an innovative modular which offers practical and professional refrigerated storage at an economical price. The room is ideal for cold storage in hotels, restaurants, cafes, shops and canteen kitchens.

The rooms are available in storage volumes between 2 and 20m³ and is the most cost effective cold storage solution per m³ in the market place.

The cold rooms can be assembled entirely from the inside making it perfect for installation in rooms where space is tight. The insulated panels are assembled with cam locks which consist of an anticorrosion cam and pin allowing a quick and easy assembly without the need for cutting.

The wall and ceiling panels are constructed from galvanised steel finished in a durable white food safe lacquer. The reinforced floor panels are constructed from phenolic resin for a long lasting hard wearing finish.

The door is fitted with a handle on both the inside and outside for completely safe operation and has a usable opening size of 1830 x 700mm.

CHILLER AND FREEZER ROOMS 2M HIGH*

WIDTH	DEPTH	M ³	CHILLER ROOM	FREEZER ROOM	CHILLER MOTOR	FREEZER MOTOR
1770	970	2.34	£2,214	£2,381	£2,318	£2,983
1770	1170	2.93	£2,324	£2,408	£2,318	£2,983
1770	1370	3.51	£2,616	£2,782	£2,318	£2,983
1770	1570	4.1	£2,901	£3,041	£2,318	£2,983
1770	1770	4.68	£2,950	£3,117	£2,318	£2,983
1770	1970	5.27	£3,068	£3,234	£2,318	£2,983
1770	2170	5.86	£3,261	£3,344	£2,318	£2,983
1770	2370	6.44	£3,638	£3,803	£2,492	£3,223
1770	2570	7.03	£3,573	£3,738	£2,492	£3,223
1770	2770	7.61	£3,858	£4,023	£2,492	£3,223
1770	2970	8.2	£3,897	£4,062	£2,723	£3,223
1770	3170	8.78	£4,105	£4,270	£2,723	£3,223
2170	970	2.93	£2,369	£2,536	£2,318	£2,983
2170	1170	3.66	£2,664	£2,830	£2,318	£2,983
2170	1370	4.39	£2,796	£2,962	£2,318	£2,983
2170	1570	5.12	£3,268	£3,435	£2,318	£2,983
2170	1770	5.86	£3,261	£3,427	£2,318	£2,983
2170	1970	6.59	£3,461	£3,626	£2,318	£3,223
2170	2170	7.32	£3,601	£3,767	£2,318	£3,223
2170	2370	8.05	£4,060	£4,225	£2,492	£3,223
2170	2570	8.78	£3,929	£4,096	£2,492	£3,223
2170	2770	9.52	£4,305	£4,471	£2,492	£3,223
2170	2970	10.25	£4,276	£4,443	£2,723	£3,223
2170	3170	10.98	£4,577	£4,744	£2,723	£3,223
2570	970	3.51	£2,616	£2,782	£2,318	£2,983
2570	1170	4.39	£2,837	£3,002	£2,318	£2,983
2570	1370	5.27	£3,201	£3,367	£2,318	£3,223
2570	1570	6.15	£3,481	£3,646	£2,492	£3,223
2570	1770	7.03	£3,474	£3,640	£2,492	£3,223
2570	1970	7.91	£3,695	£3,860	£2,492	£3,223
2570	2170	8.78	£3,929	£4,096	£2,723	£3,223
2570	2370	9.66	£4,327	£4,493	£2,723	£3,223
2570	2570	10.54	£4,326	£4,491	£2,723	£3,223
2570	2770	11.42	£4,617	£4,784	£3,189	£4,044
2570	2970	12.3	£4,638	£4,803	£3,189	£4,044
2570	3170	13.18	£4,932	£5,097	£3,189	£4,044
2970	970	4.1	£2,922	£3,089	£2,318	£2,983
2970	1170	5.12	£3,073	£3,239	£2,318	£2,983
2970	1370	6.15	£3,408	£3,573	£2,492	£3,223
2970	1570	7.17	£3,786	£3,952	£2,492	£3,223
2970	1770	8.2	£3,898	£4,064	£2,723	£3,223
2970	1970	9.22	£4,041	£4,207	£2,723	£3,223
2970	2170	10.25	£4,274	£4,441	£2,723	£3,223
2970	2370	11.27	£4,746	£4,912	£3,189	£3,223
2970	2570	12.3	£4,638	£4,803	£3,189	£3,223
2970	2770	13.32	£5,033	£5,200	£3,189	£4,044
2970	2970	14.35	£5,146	£5,312	£3,189	£4,044
2970	3170	15.37	£5,367	£5,532	£3,189	£4,044

WAREWASHING

Prodis

GLASS WASHERS
DISHWASHERS
HOOD DISHWASHERS
POT WASHERS
RACK CONVEYOR DISHWASHERS
ACCESSORIES

STAND OUT

Graphic Finish

Images and logos are prepared and inkjet printed onto an adhesive vinyl film.

The graphics are then reinforced with a durable plastic coating that can withstand temperatures of up to 90°C.

The end product is a hard wearing and attractive machine which can create a statement about your business or brand identity





Veneered Finish

Over 500 patterns available in 25 groups you can select a finish that will perfectly match your interior design to allow the machine to perfectly blend in to its surroundings.

Simulated decorative finishes can be supplied in wood, metal, leather, stone, metallic and a multitude of other finishes.

These simple but effective finishes allow you to install your machine in plain sight whilst keeping it in sympathy with your venue design.



**NEW
PRODUCT**

Standard Features

- Simple one touch operation
- Easy to understand intuitive control panel
- Waterproof flat LED control panel
- Bright LED display, suitable for use in even the darkest environments
- Two stage micro particulate primary pump filter
- Stainless steel construction
- 1,2,3,4 & 10 minute wash cycles
- Removable rack guides for easy cleaning
- Hygienic rounded wash tank
- Rinseaid & detergent injectors
- Drain pump as standard
- Robust lightweight composite wash arms
- Soft start wash pump
- Automatic clean down cycle
- Intelligent self diagnostic system
- Adjustable wash tank temperature (55°C default)
- Adjustable rinse tank temperature (82°C default)
- Optional 82°C rinse tank interlock

Options

- Secondary tank filters*
- External water softener
- Rinse boost pump
- Multifit stand



Two stage micro particulate filter

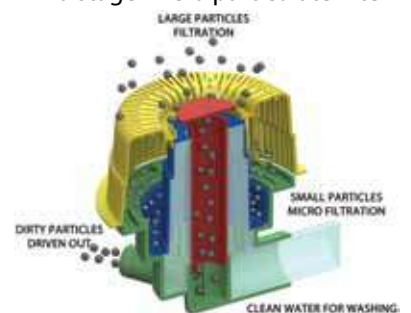

EV-SERIES GLASS WASHERS

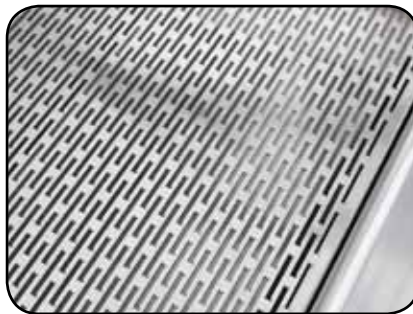
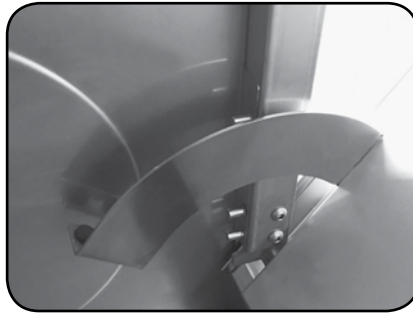

EV A new range of glass washers by Prodis. Designed from the ground up to be user friendly, energy efficient, intelligent and hygienic.

The bright LED display can easily be read in low light situations allowing easy operation in pubs, clubs and bars.

User friendly, intuitive and informative. The large LED control panel features a bright colour coded display with easy to read illuminated buttons. This allows for easy operation and makes staff training effortless due to its simplicity.

Combining years of research and development the **EV-CLEAN** delivers the perfect result every time. The **EV** wash tank is designed without any obstruction to allow for effortless cleaning. Filters, rack guides and wash arms are ergonomically profiled to allow for easy access and removal. The innovative system automatically cleans the wash tank whenever the unit is switched off making sure your **EV** is ready for use the next day with minimal effort.

Our advanced **EV-FILTER** technology has been developed to keep both small and large dirt particles out of the wash system, delivering excellent results while keeping the components clean.

All **EV** machines are fitted with a soft start wash pump which gradually ramps up the power to prevent chipping and breaking of delicate glassware.

EV-LOGIC is our self diagnostic system which monitors the machines performance at all times and displays user friendly error codes which speed up troubleshooting greatly reducing the amount of downtime in the unlikely event of a breakdown.



MODEL	BASKET	DRAIN	SOFTENER	POWER	CLEARANCE	WIDTH	DEPTH	HEIGHT	LIST PRICE
EV35G	2 x 350mm	Gravity	No	2.5kw	220mm	430	485	660	£1330
EV35	2 x 350mm	Pumped	No	2.5kw	220mm	430	485	660	£1490
EV40G	2 x 400mm	Gravity	No	2.5kw	276mm	480	517	696	£1470
EV40	2 x 400mm	Pumped	No	2.5kw	276mm	480	517	696	£1700
EV40S	2 x 400mm	Pumped	Yes	2.5kw	276mm	480	517	696	£2140
EV50G	2 x 500mm	Gravity	No	6.6kw	355mm	575	600	805	£2140
EV50	2 x 500mm	Pumped	No	6.6kw	355mm	575	600	805	£2260
EV50S	2 x 500mm	Pumped	Yes	6.6kw	355mm	575	600	805	£2750

Standard Features

- Stainless steel construction
- Double skinned door
- Adjustable thermostats
- 2 minute wash cycle (E35, E40)
- 2/4 minute wash cycle (E80X)
- 13 amp operation (E35, E40)
- 30 amp operation (E80X)
- Timed rinse aid pump
- Timed detergent pump
- Wash and rinse tank elements
- Compact elegant design
- Pressed, hygienic door handle
- Adjustable feet
- Stainless steel wash pump filter
- Secondary tank filters (E40P, E80X)
- WRAS Approved

Optional Features

- External water softener
- Rinse boost pump
- Multifit stand
- Vinyl wrapping (see page 106-107)



Prodis

E-SERIES GLASS WASHERS



MODEL	BASKET	DRAIN	POWER	CLEARANCE	WIDTH	DEPTH	HEIGHT	LIST PRICE
E35	2 x 350mm	Gravity	2.85kw	220mm	400	470	615	£1330
E40	2 x 400mm	Gravity	2.85kw	255mm	450	520	695	£1470
E40P	2 x 400mm	Pumped	2.85kw	255mm	450	520	695	£1780
E80X	2 x 500mm	Gravity	6.5kw	330mm	550	600	835	£2140
E80XP	2 x 500mm	Pumped	6.5kw	330mm	550	600	835	£2330



JET-SERIES GLASS WASHERS

UPDATED
DESIGN

Standard Features

- Stainless steel construction
- Double skinned door
- Ergonomic full width door handle
- 2 minute wash cycle
- 13 amp for easy installation
- Timed rinse aid pump
- Timed detergent pump (Exc. JET35E)
- Wash and rinse tank elements
- 60°C fixed wash tank thermostat
- 80°C fixed rinse tank thermostat
- Compact design
- Simple operation
- Adjustable feet
- Stainless steel wash pump filter

Optional Features

- External water softener
- Rinse boost pump
- Multifit stand
- Double check valve
- Vinyl wrapping (see page 112-113)

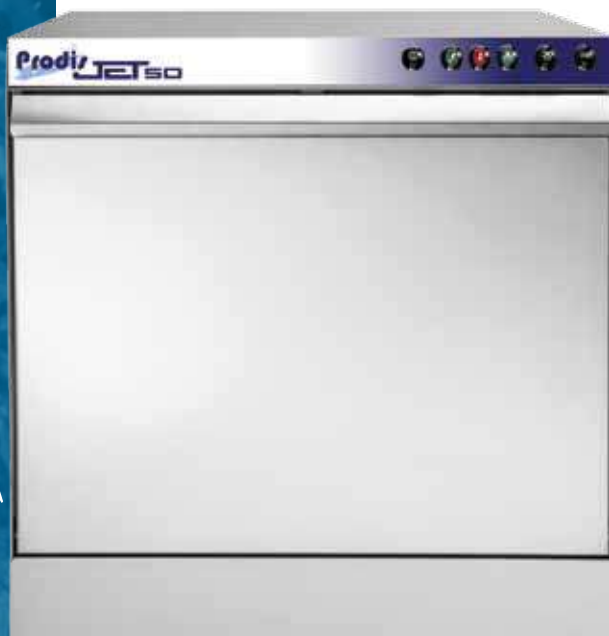

Prodis

JET-SERIES GLASS WASHERS

**BEST
SELLER**

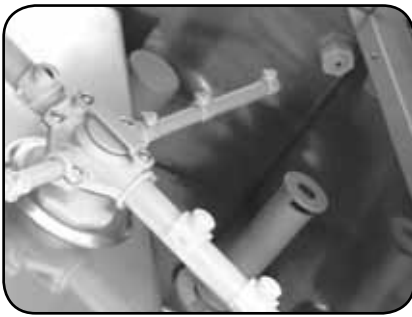

Stainless steel wash tank



Extra large loading height



Ergonomic full width door handle



Clean design

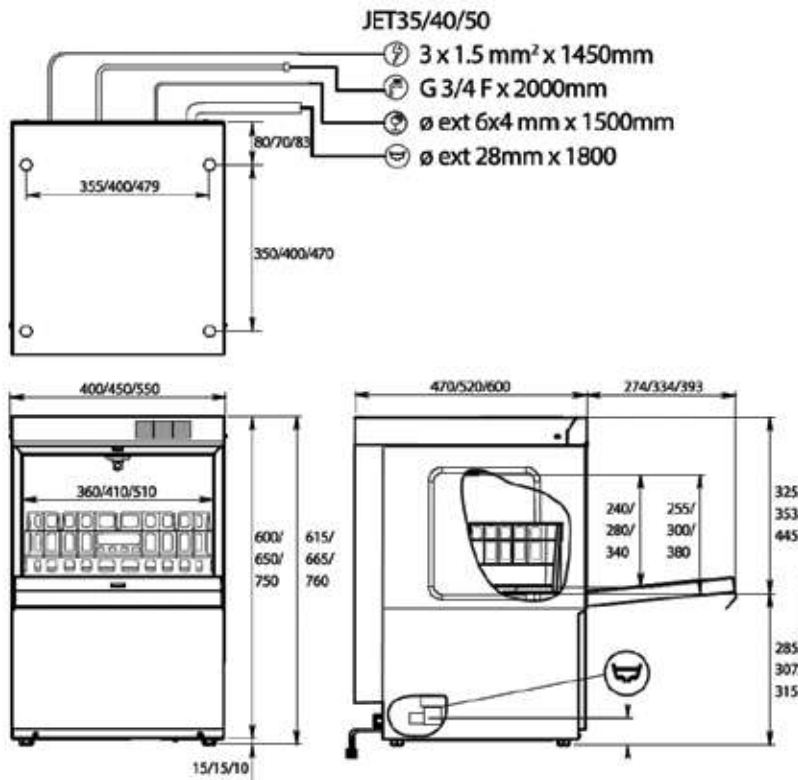

MODEL	BASKET	DRAIN	POWER	CLEARANCE	WIDTH	DEPTH	HEIGHT	LIST PRICE
JET35E	1 x 350mm	Gravity	2.8kw	230mm	400	470	615	£1060
JET35	1 x 350mm	Gravity	2.8kw	230mm	400	470	615	£1110
JET35P	1 x 350mm	Pumped	2.8kw	230mm	400	470	615	£1380
JET40	1 x 400mm	Gravity	2.8kw	265mm	450	520	665	£1260
JET40P	1 x 400mm	Pumped	2.8kw	265mm	450	520	665	£1520
JET50	1 x 500mm	Gravity	2.8kw	345mm	550	600	760	£1740
JET50P	1 x 500mm	Pumped	2.8kw	345mm	550	600	760	£1930

JET-SERIES DISHWASHERS

**UPDATED
DESIGN**

Standard Features

- Stainless steel construction
- Double skinned door
- 4 minute wash cycle
- 13 amp for easy installation
- Timed rinse aid pump
- Timed detergent pump
- Supplied with 2 x baskets
- Wash and rinse tank elements
- 60°C fixed wash tank thermostat
- 80°C fixed rinse tank thermostat
- Compact design
- Simple operation
- Adjustable feet
- Stainless steel wash pump filter
- Secondary tank filters

Optional Features

- External water softener
- Rinse boost pump

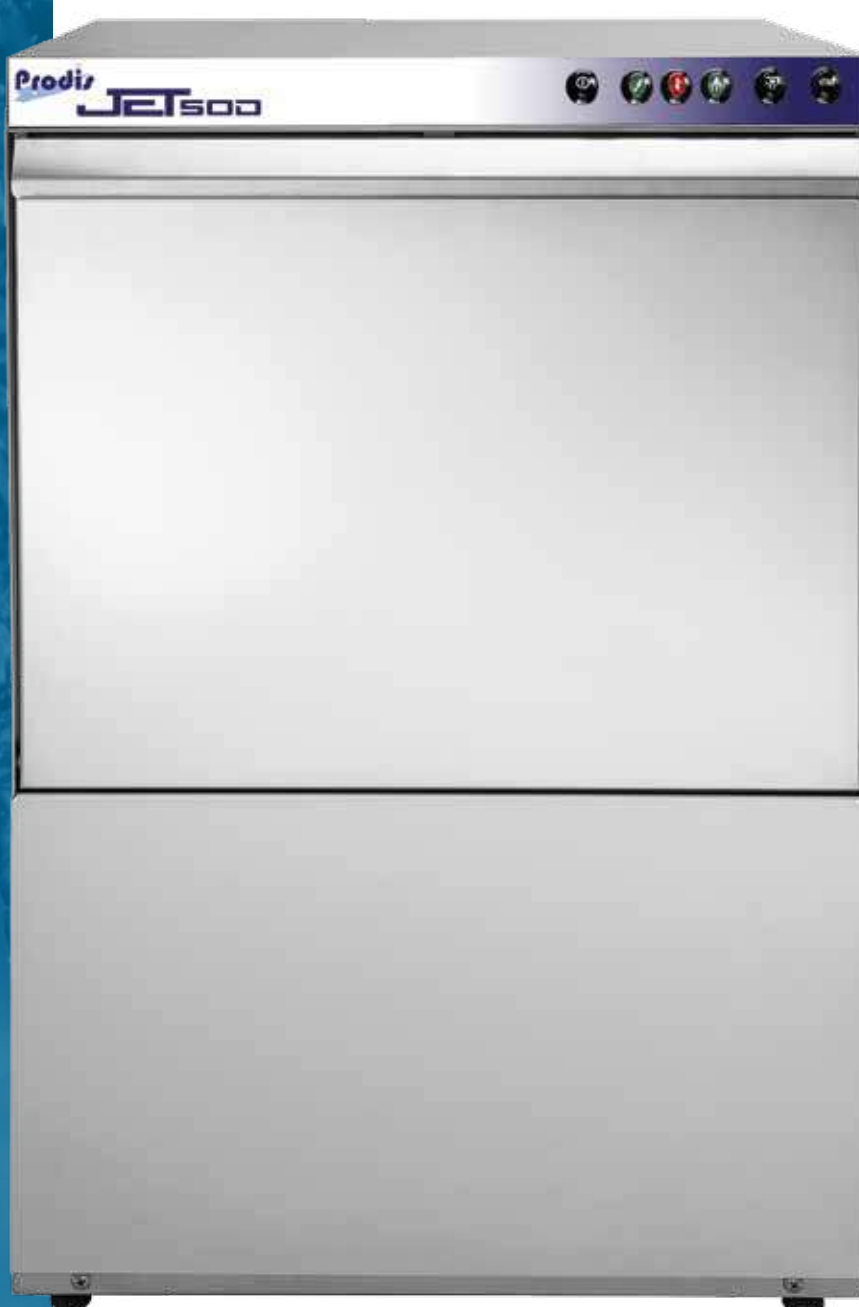

MODEL	BASKET	DRAIN	POWER	CLEARANCE	WIDTH	DEPTH	HEIGHT	LIST PRICE
JET50D	2 x 500mm	Gravity	2.8kw	345mm	550	600	760	£1910
JET50DP	2 x 500mm	Pumped	2.8kw	345mm	550	600	760	£2100

**NEW
PRODUCT**



**2
YEAR
PARTS
ONLY
WARRANTY**

Standard Features

- Simple one touch operation
- 500mm basket size (2 supplied)
- Easy to understand intuitive control panel
- Waterproof flat LED control panel
- Bright LED display, suitable for use in even the darkest environments
- Two stage micro particulate primary pump filter
- Stainless steel construction
- 1,2,3,4 & 10 minute wash cycles
- Removable rack guides for easy cleaning
- Hygienic rounded wash tank
- Rinseaid & detergent injectors
- Drain pump as standard
- Robust lightweight composite wash arms
- Soft start wash pump
- Type 'A' air gap
- Internal rinse boost pump
- Automatic clean down cycle
- Intelligent self diagnostic system
- Adjustable wash tank temperature (55°C default)
- Adjustable rinse tank temperature (82°C default)
- Optional 82°C rinse tank interlock

Options

- Secondary tank filters
- External water softener
- Multifit stand



MODEL	DRAIN	BREAK TANK	SOFTENER	POWER	WIDTH	DEPTH	HEIGHT	LIST PRICE
EV50G	Gravity	No	No	6.6kW	575	600	805	£2100
EV50	Pumped	No	No	6.6kW	575	600	805	£2220
EV50S	Pumped	No	Yes	6.6kW	575	600	805	£2710
EV80	Pumped	Yes	No	4.6kW	575	600	805	£2590

T SERIES HOOD DISHWASHERS

Standard Features

- Soft touch electronic controls for simple operation
- Auto start as standard
- 470w wash pump
- 15 litre wash tank
- 90" & 120" wash cycles
- Automatic timed peristaltic detergent and rinseaid pumps
- Constructed entirely from stainless steel
- Deep drawn one piece wash tank for easy cleaning
- Secondary wash tank filters
- Primary wash pump filter
- Rotating parallel upper and lower wash arms
- Supplied with 1 x dish basket, 1 x glass basket, 1 x cutlery basket
- Single phase operation



Intuitive simple to use soft touch electronic control panels fitted to all machines as standard.



One piece deep drawn wash tanks as standard allow for quick and easy clean down at the end of day by removing dirt traps.



Large loading heights across the range make the T Series as versatile as it is reliable.

MODEL	BREAK TANK	POWER SUPPLY	CLEARANCE	WIDTH	DEPTH	HEIGHT	LIST PRICE
T1115	No	230/50/1 5.6kw	450mm	634	818	2010	£3390
T1115BT	Yes	230/50/1 5.6kw	450mm	634	818	2010	£3680
OPTIONS							
PRTDP	Drain pump						£350
PRTIWS	Built In Water Softener (requires air break tank)*						£620
PRTDSH	Double Skinned Hood*						£260
T80202	700mm exit table right (for alternative sizes see page 124)						£620
T80205	1200mm entry table left with sink (for alternative sizes see page 124)						£1480



Standard Features

- Soft touch electronic controls for simple operation
- Auto start as standard
- 700w wash pump
- 20 litre wash tank capacity
- 60", 120", 180" & continuous wash cycles
- Automatic timed peristaltic detergent and rinseaid pumps
- Constructed entirely from stainless steel
- Deep drawn one piece wash tank for easy cleaning
- Secondary wash tank filters
- Primary wash pump filter
- Rotating parallel upper and lower wash arms
- Supplied with 1 x dish basket, 1 x glass basket, 1 x cutlery basket
- Single or three phase operation



Intuitive simple to use electronic control



Deep drawn rounded wash tank



Stainless steel wash and rinse arms



Secondary wash tank filters



Patented parallel wash group assembly



Ergonomic durable one piece handle



MODEL	BREAK TANK	POWER SUPPLY	CLEARANCE	WIDTH	DEPTH	HEIGHT	LIST PRICE
T1215 -3NT	No	400/50/3	8.7kw	450mm	634	818	2010 £3800
T1215BT-3NT	Yes	400/50/3	8.7kw	450mm	634	818	2010 £4090
T1215	No	230/50/1	6kw	450mm	634	818	2010 £3800
T1215BT	Yes	230/50/1	6kw	450mm	634	818	2010 £4090
OPTIONS							
PRTDP	Drain pump						£350
PRTIWS	Built In Water Softener (requires air break tank)*						£620
PRTDSH	Double Skinned Hood*						£260
T80202	700mm exit table right (for alternative sizes see page 124)						£620
T80205	1200mm entry table left with sink (for alternative sizes see page 124)						£1480

*Factory order options lead times apply

T SERIES HOOD DISHWASHERS

Standard Features

- Large 600 x 500 gastronorm compatible basket size
- Soft touch electronic controls for simple operation
- Auto start as standard
- 1500w wash pump
- 30 litre wash tank
- 60", 120", 180" & continuous wash cycles
- Automatic timed peristaltic detergent and rinseaid pumps
- Constructed entirely from stainless steel
- Deep drawn one piece wash tank for easy cleaning
- Secondary wash tank filters
- Primary wash pump filter
- Hinged basket support
- Rotating parallel upper and lower wash arms
- Supplied with 1 x dish basket, 1 x glass basket, 1 x cutlery basket
- Three phase operation



Hinged basket support allows for quicker and easier access to the wash tank for cleaning.



One piece deep drawn wash tanks as standard allow for quick and easy clean down at the end of day by removing dirt traps.



Large loading heights across the range make the T Series as versatile as it is reliable.



Optional entry sinks and exit tables can be specified to create an efficient wash area.



MODEL	BREAK TANK	POWER SUPPLY	CLEARANCE	WIDTH	DEPTH	HEIGHT	LIST PRICE
T1515	No	400/50/3 9.5kw	465mm	700	835	2080	£5090
T1515BT	Yes	400/50/3 9.5kw	465mm	700	835	2080	£5400
OPTIONS							
PRTDP	Drain pump						£350
PRTIWS	Built In Water Softener (requires air break tank)*						£620
PRTDSH	Double Skinned Hood*						£260
T80202	700mm exit table right (for alternative sizes see page 124)						£620
T80205	1200mm entry table left with sink (for alternative sizes see page 124)						£1480

T SERIES HOOD DISHWASHERS



Reduce energy and create a more pleasant working environment with optional steam condensing / heat recovery units.



One piece deep drawn wash tanks as standard allow for quick and easy clean down at the end of day by removing dirt traps.



Hinged basket support allows for quicker and easier access to the wash tank for cleaning.



Standard Features

- Energy efficient heat recovery module
- Large 600 x 500 gastronorm compatible basket size
- Soft touch electronic controls for simple operation
- Auto start as standard
- 1500w wash pump
- 30 litre wash tank
- 60", 120", 180" & continuous wash cycles
- Automatic timed peristaltic detergent and rinseaid pumps
- Constructed entirely from stainless steel
- Deep drawn one piece wash tank for easy cleaning
- Secondary wash tank filters
- Primary wash pump filter
- Hinged basket support
- Rotating parallel upper and lower wash arms
- Supplied with 1 x dish basket, 1 x glass basket, 1 x cutlery basket
- Three phase operation



MODEL	BREAK TANK	POWER SUPPLY	CLEARANCE	WIDTH	DEPTH	HEIGHT	LIST PRICE		
T1515BTHR	Yes	400/50/3	9.5kw	465mm	700	835	2264	£9680	
OPTIONS									
PRTDP								Drain pump	£350
PRTIWS								Built In Water Softener (requires air break tank)*	£620
PRTDSH								Double Skinned Hood*	£260
T80202								700mm exit table right (for alternative sizes see page 124)	£620
T80205								1200mm entry table left with sink (for alternative sizes see page 124)	£1480

*Factory order options lead times apply

S SERIES POT WASHERS

S100 Features

- Stainless steel construction
- Double skinned for energy efficiency and quiet operation
- Powerful twin wash pumps
- Large internal clearance
- Stainless steel wash tank filters
- 1,2,3 & 4 minute wash cycles
- Timed rinse aid pump
- Powerful 6kw rinse element
- 2 x 1.5kw wash tank elements
- Simple operation
- Includes 3 x baskets

S200 Features

- Stainless steel construction
- Double skinned for energy efficiency and quiet operation
- Cycle end buzzer to alert user when wash cycle is complete
- Easy to use intelligent electronic controls
- Easy to open split door system
- Large 850mm internal clearance
- Stainless steel wash tank filters
- Four wash cycles 2-12 minutes
- Timed rinseaid and detergent pumps
- Self cleaning cycle at end of use
- 700 x 700mm rack
- Integrated rinse boost pump
- Three phase operation



2
YEAR
PARTS
ONLY
WARRANTY

SPECIAL ORDER



S100



S200



S200



S200

MODEL	BASKET	DRAIN	POWER	CLEARANCE	WIDTH	DEPTH	HEIGHT	LIST PRICE
S100	550mm	Gravity	7.13kw	500mm	650	845	1640	£4550
S200	700mm	Gravity	11kw	850mm	850	850	2250	£10800

S SERIES POT WASHERS



Standard Features

- Stainless steel construction
- Easy to open split door system
- Stainless steel wash tank filters
- Double skinned for energy efficiency and quiet operation
- Cycle end buzzer to alert user when wash cycle is complete
- Easy to use intelligent electronic controls
- Large 850mm internal clearance
- Four wash cycles 2 - 12 minutes
- Timed rinse and detergent pumps
- Self cleaning cycle at end of use
- Energy saving half load function
- 700 x 1320mm rack
- Integrated rinse boost pump
- Three phase operation

2
YEAR

**PARTS
ONLY**

WARRANTY

SPECIAL ORDER



MODEL	BASKET	DRAIN	POWER	CLEARANCE	WIDTH	DEPTH	HEIGHT	LIST PRICE
S350	700 x 1320	Gravity	15.5kw	850mm	1470	850	1960	£16000

CT120 RACK CONVEYOR

**NEW
PRODUCT**

The CT120 is an ultra compact rack conveyor dishwasher capable of washing up to 120 racks per hour.

A double skinned construction guarantees a quieter operation and cooler working environment saving energy.

The CT120 is equipped with a timer which automatically shuts down the machine when not in use, reducing running costs.

The wash pump is self draining meaning no water is left in the machine after use and the wash tank is completely rounded making cleaning at the end of the day extremely easy.

Full width doors allow for easy and safe access to the machine and the simple and clear electronic controls make operating the CT120 easy for the user.

The direction of the conveyor system is reversible so the CT120 can be easily installed in any kitchen.

A built in electric drying module and heat recovery unit are available as options.



**2
YEAR
PARTS
ONLY
WARRANTY**

SPECIAL ORDER

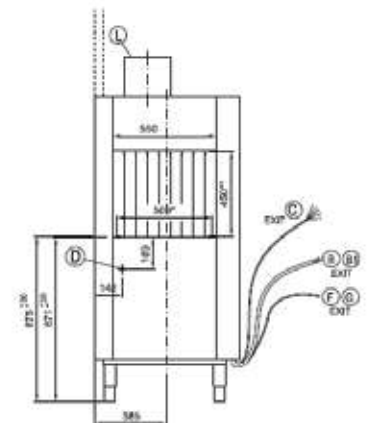
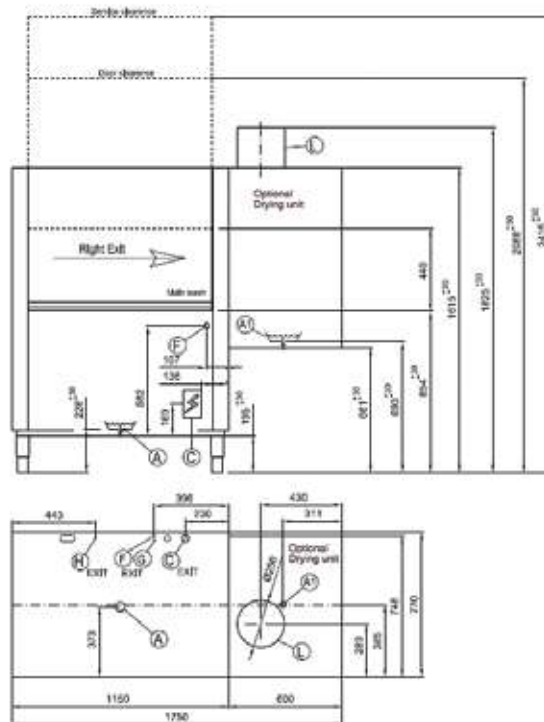

* USEFUL WIDTH FOR BASKET
** USEFUL HEIGHT FOR BASKET

CT120 RACK CONVEYOR



CT120 with optional entry and exit tables

Standard Features

- Up to 120 racks per hour*
- Up to 2160 plates per hour*
- Stainless steel double skinned construction
- Stainless steel tank filters
- Two selectable speeds
- Reversible on site
- Tank autotimer
- Rinse tank thermostop
- 10.5kW rinse tank element
- 10.5kW wash tank element
- Powerful 1.5kW (750 l/min) wash pump
- 70 litre wash tank capacity
- 17 litre rinse boiler capacity
- Low water consumption (1.3 litres per cycle)
- Three phase operation
- 500 x 500 basket size

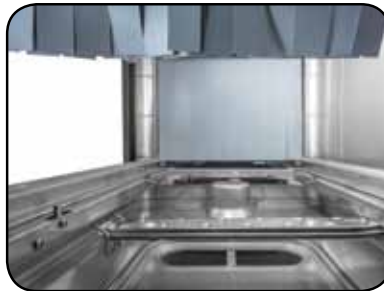
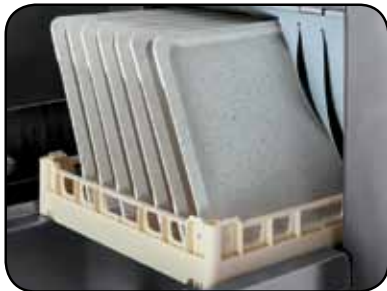
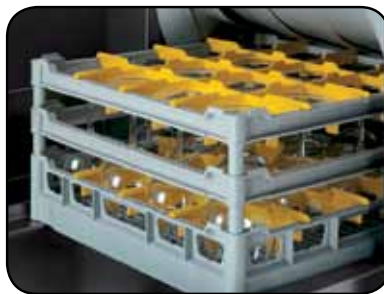

Optional Features

- Cold fill operation (29.7kW)
- Cold fill operation with heat recovery (25.2kW)
- Inlet and outlet tables
- Drying module

MODEL	BASKET	DRAIN	POWER	CLEARANCE	WIDTH	DEPTH	HEIGHT	LIST PRICE
CT120	500mm	Gravity	23.5kW	450mm	1150	770	1615/2088	£10600
CTTA			6kw Inline Drying Module					£5910
CTRC			Heat Recovery Unit					£5000

*theoretical capacity with hot water fill and continuous operation

Prodis

CT200 RACK CONVEYOR

**NEW
PRODUCT**

The CT200 rack conveyor dishwasher with integrated prewash capable of washing up to 200 racks per hour.

A double skinned construction guarantees a quieter operation and cooler working environment saving energy.

The CT200 is equipped with a timer which automatically shuts down the machine when not in use, reducing running costs.

The wash pump is self draining meaning no water is left in the machine after use and the wash tank is completely rounded making cleaning at the end of the day extremely easy.

Full width doors allow for easy and safe access to the machine and the simple and clear electronic controls make operating the CT200 easy for the user.

A built in electric drying module and heat recovery unit are available as options.



**2
YEAR
PARTS
ONLY
WARRANTY**

SPECIAL ORDER

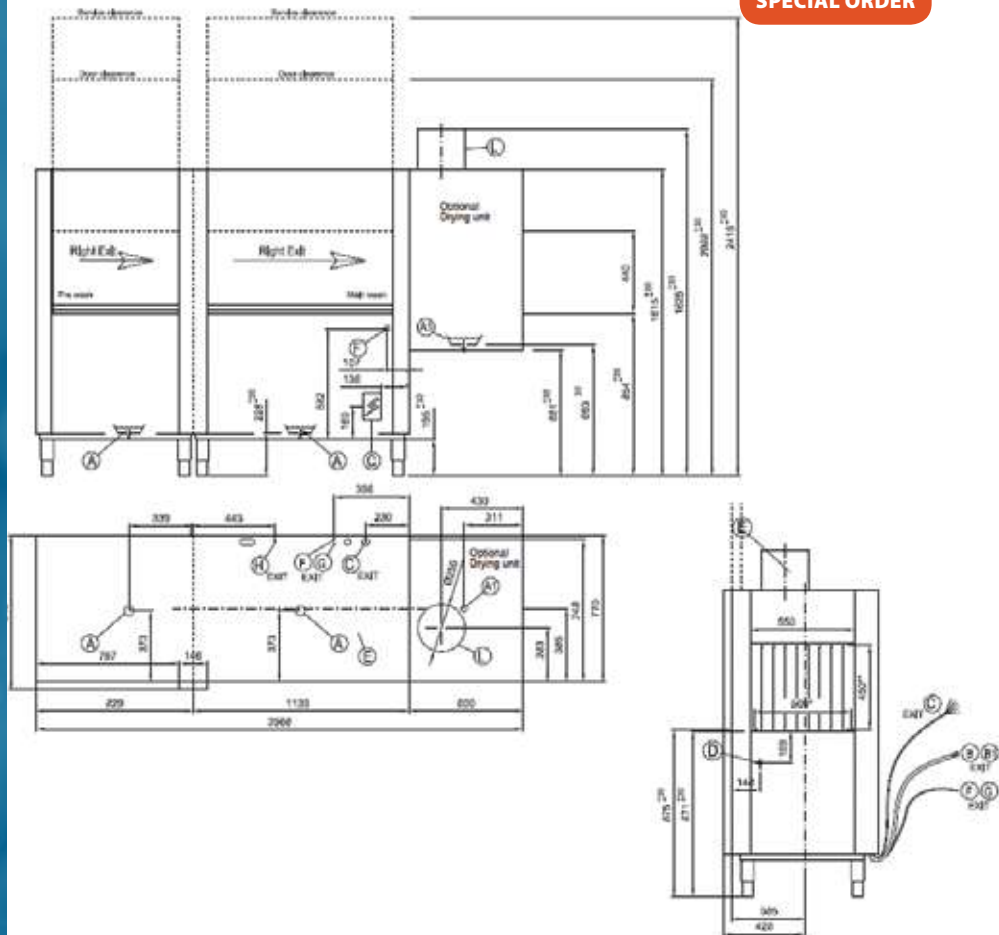

* USEFUL WIDTH FOR BASKET
** USEFUL HEIGHT FOR BASKET

CT200 RACK CONVEYOR



CT200 with optional entry and exit tables

Standard Features

- Up to 200 racks per hour*
- Up to 3600 plates per hour*
- Stainless steel double skinned construction
- Stainless steel tank filters
- Two selectable speeds
- Reversible on site
- Tank autotimer
- Rinse tank thermostop
- 16kW rinse tank element
- 10.5kW wash tank element
- Twin 1.5kW (750 l/min) wash pumps
- 70 litre pre wash tank capacity
- 70 litre wash tank capacity
- 17 litre rinse boiler capacity
- Low water consumption (1.3 litres per cycle)
- Three phase operation
- 500 x 500 basket size

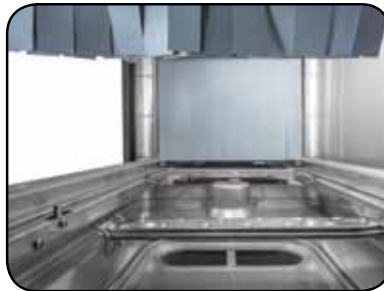
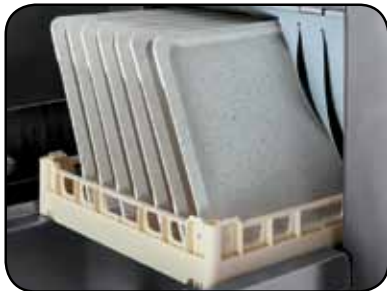

Optional Features

- Cold fill operation (42.2kW)
- Cold fill operation with heat recovery (34.2kW)
- Inlet and outlet tables
- Drying module

MODEL	BASKET	DRAIN	POWER	CLEARANCE	WIDTH	DEPTH	HEIGHT	LIST PRICE
CT200	500mm	Gravity	30.2kW	450mm	1970	770	1615/2088	£17000
CTTA			6kw Inline Drying Module					£5910
CTRC			Heat Recovery Unit					£5000

*theoretical capacity with hot water fill and continuous operation

ENTRY / EXIT TABLES - T SERIES

MODEL	DESCRIPTION	WIDTH	DEPTH	HEIGHT	LIST PRICE
T80202	700mm Exit Table	700	615	850	£620
T80202L	1200mm Exit Table	1200	615	850	£715
T80200	700mm Exit Table (Right) With Splashback	700	720	850	£755
T80201	700mm Exit Table (Left) With Splashback	700	720	850	£755
T80204	1200mm Exit Table (Right) With Splashback	1200	720	850	£1000
T80203	1200mm Exit Table (Left) With Splashback	1200	720	850	£1000
T80206L	700mm Entry Table (Right) With Sink & Splashback	700	720	850	£1365
T80205L	700mm Entry Table (Left) With Sink & Splashback	700	720	850	£1365
T80206	1200mm Entry Table (Right) With Sink & Splashback	1200	720	850	£1515
T80205	1200mm Entry Table (Left) With Sink & Splashback	1200	720	850	£1515
T80208	1200mm Entry Table (Right) With Sink, Scrape Hole & Splashback	1200	720	850	£1615
T80207	1200mm Entry Table (Left) With Sink, Scrape Hole & Splashback	1200	720	850	£1615

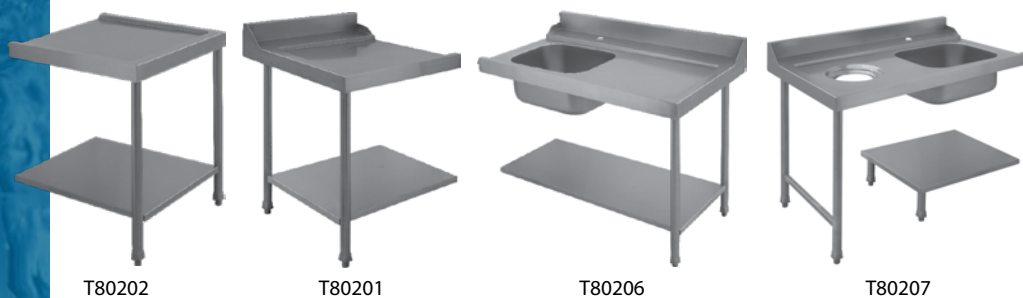

T80202

T80201

T80206

T80207

BASKETS

MODEL	DESCRIPTION	WIDTH	DEPTH	LIST PRICE
CPP3501	350mm Glass Rack	350	350	£50
CPP4001	400mm Glass Rack	400	400	£60
CPP5001	500mm Glass Rack	500	500	£70
CPP5002	500mm Dish Rack	500	500	£70
30740	Insert Saucer Rack			£40
30750	Insert Cutlery Holder			£40



30750



WS08



30740

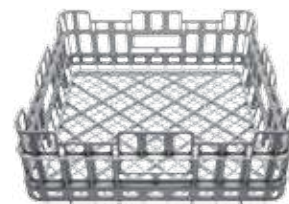

CPP4001

INSTALLATION ACCESSORIES AND WATER TREATMENT

MODEL	DESCRIPTION	LIST PRICE
PRMFS	Multifit Stand Glasswashers Dishwashers Icemakers	£120
RPB	External Rinse Boost Pump	£260
WS08	8 Litre Manual Water Softener	£140
WS12	12 Litre Manual Water Softener	£160
WS16	16 Litre Manual Water Softener	£240
4H	Everpure 4H Icemaker Water Filter	£120
i2000	Everpure i2000 Icemaker Water Filter	£200
QL3B	Everpure Head Unit For 4H / i2000	£100

CATERING EQUIPMENT



FRYERS
GRIDDLES
CONTACT GRILLS
SALAMANDER GRILLS
PIE CABINETS
CREPE STATIONS
SOUP STATIONS



FDF SERIES FRYERS

Standard Features

- Variable thermostats for precise control
- High limit safety cut out thermostat
- Lift out stainless steel tank (FDF7, FDF77)
- Drain taps for easy drain down and cleaning (FDF11T, FDF22T)
- Cool to touch basket handles
- Pivoting fryer head
- Oil level indicators
- Complete with stainless steel lids, baskets and batter plates
- 13 amp operation for easy installation



1
YEAR
PARTS ONLY
WARRANTY

MODEL	CAPACITY	DRAIN TAPS	POWER	WIDTH	DEPTH	HEIGHT	LIST PRICE
FDF7	7 Litres	No	3kw	275	670	326	£206
FDF77	2 x 7 Litres	No	2 x 3kw	570	670	376	£316



FDF SERIES FRYERS

Standard Features

- Variable thermostats for precise control
- High limit safety cut out thermostat
- Drain taps for easy drain down and cleaning
- Cool to touch basket handles
- Pivoting fryer head
- Oil level indicators
- Complete with stainless steel lids, baskets and batter plates
- Mechanical timer
- Powerful 6kw 30amp operation for quick heat-up



1
YEAR
PARTS ONLY
WARRANTY

MODEL	CAPACITY	DRAIN TAPS	POWER	WIDTH	DEPTH	HEIGHT	LIST PRICE
FDF106	10 Litres	Yes	6kw	290	770	456	£430
FDF206	2 x 10 Litres	Yes	2 x 6kw	600	770	456	£710

Prodis

FGR SERIES GRIDDLES

Standard Features

- Stainless steel construction
- Steel cooking plate
- Adjustable thermostat for precise control
- 50°C to 300°C temperature range
- Removable fat collection drawer
- Dual control separate cooking zones (FGR36)
- 1/3 ribbed cooking area (FGR36)



1
YEAR
PARTS
ONLY
WARRANTY

MODEL	COOKING AREA	PLATE STYLE	POWER	WIDTH	DEPTH	HEIGHT	LIST PRICE
FGR24	600 x 400	Flat	3kw	605	588	227	£460
FGR36	900 x 400	2/3 Flat	2 x 3kw	906	588	227	£700

Prodis

FCG SERIES CONTACT GRILLS

Standard Features

- Variable thermostats for precise control
- 60°C to 300°C temperature range
- Adjustable cooking height
- Adjustable handle tension
- High limit cut out safety thermostats to rear
- Stainless steel construction
- Cast iron cooking surface
- Removable fat collection drawer
- Large stay cool handles
- Stay open sprung top plate



1
YEAR
PARTS
ONLY
WARRANTY

MODEL	PLATE STYLE	COOKING AREA	POWER	WIDTH	DEPTH	HEIGHT	LIST PRICE
FCG1		290 x 380	2400w	410	520	270	£380



FAS SERIES SALAMANDER

Standard Features

- Rise and fall salamander grill
- Adjustable cooking height
- Stainless steel construction
- 2/3 gastronorm base
- 347 x 412 cooking area
- Quartz heating elements
- Rapid heat up from cold
- Removable base tray
- Reaches up to 260°C



MODEL	CAPACITY	COOKING AREA	POWER	WIDTH	DEPTH	HEIGHT	LIST PRICE
FAS23	2/3 GN	347 x 412mm	2.2kw	485	520	530	£530



FCS SERIES CREPE STATION

Standard Features

- Mobile crepe serving station
- Stainless steel construction
- GN containers, bowls, spreader and spatula included
- Removable toughened safety glass
- Hot cupboard with castors
- Hot cupboard requires 13amp supply



MODEL	SURFACE	DESCRIPTION	POWER	WIDTH	DEPTH	HEIGHT	LIST PRICE
FCS1	400mm	Mobile Station	2.7kw +750w	830	645	1150	£1090

Prodis

FPC SERIES PIE CABINETS



1
YEAR
PARTS
ONLY
WARRANTY

Standard Features

- Holds food at +85°C
- Removable shelves
- Internal illumination
- Toughened glass doors
- Water reservoir
- Adjustable thermostat
- Digital temperature display
- 13amp operation

MODEL	CAPACITY	SHELVES	POWER	WIDTH	DEPTH	HEIGHT	LIST PRICE
FPC20	20 Pies	2	300w	400	370	446	£340
FPC60	60 Pies	3	750w	753	400	615	£410

Prodis

FSS SERIES SOUP STATIONS



1
YEAR
PARTS
ONLY
WARRANTY

Standard Features

- Black powder coated stand
- 4 litre porcelain pots included
- 5oz stainless steel ladles included
- 30°C to 80°C temperature range
- Drain valve

MODEL	CAPACITY	TEMPERATURE	POWER	WIDTH	DEPTH	HEIGHT	LIST PRICE
FSS4	4 x 4 litres	30°C to 80°C	2.8kw	530	560	455	£410

HS SERIES CONVECTION OVENS

Standard Features

- Stainless steel construction
- Stainless steel chamber
- Rounded interior corners
- Internal light
- Humidity feature to add a finishing touch to baked products (H models)
- 30°C to 280°C temperature range
- 442 x 325 tray size (4 supplied HS43)
- 600 x 400 tray size (2 supplied HS46)
- 0 to 120 minute timer
- 75mm distance between trays



HS46H



HS43GH



HS43



Drop down door

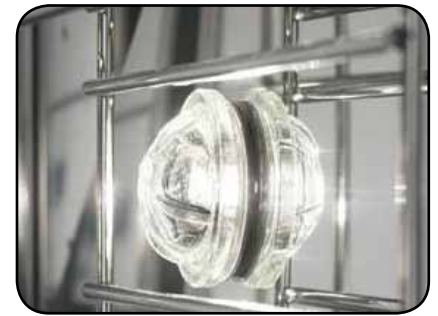

Interior Halogen Lamp



Replaceable Door Gasket

MODEL	CAPACITY	GRILL	HUMIDITY	POWER	WIDTH	DEPTH	HEIGHT	LIST PRICE
HS43	4 Trays	No	No	2.6kw	550	520	585	£1155
HS43GH	4 Trays	Yes	Yes	2.6kw	550	520	585	£1360
HS46H	4 Trays*	No	Yes	6kw	720	520	685	£1950

A series of horizontal dotted lines for writing notes.

Terms and Conditions

These conditions alone shall govern and be incorporated in every contract for the sale of goods or on behalf of Project Distribution Ltd ("the company") with any customer ("the customer")

All contracts of sale made by or on behalf of the company are subject to these conditions, unless they are excluded or varied by express written agreement between the company and the customer. In particular, the company accepts the customer's order for goods from the company shall be conclusive evidence before any court or arbitrator that these conditions apply to the sale of such goods.

1. Formation of Contract

No binding contract shall be deemed to have been effected until confirmed in writing by the Company by an acknowledgement of order or otherwise; quotations, price lists and other publications of the company shall not constitute offers.

2. Applications of Conditions

Contracts are accepted only upon and subject to the following Conditions of Sale. Unless expressly accepted in writing, any terms or conditions contained in any written or printed document of the Purchaser, inconsistent with or in any way qualifying these conditions, shall not apply.

3. Price Variation

Prices charged and discounts given will be those current at date of delivery.

4. Price and Payment

1) Selling prices are subject to alteration without prior notice and the company reserves the right to invoice at the prices ruling at the date of dispatch of the goods to take account of any increase in the cost to the company which is due to any factor beyond the company's control (including without limitation any foreign exchange fluctuations, currency regulations, alteration of duties, significant increases in the cost of labour material or other costs of manufacture), any change in delivery dates, quantities or specifications for the goods which is requested by the customer or any delay caused by instructions of the customer or failure of the customer to give the company adequate information or instructions notwithstanding the fact that some other price may have been quoted to the customer.

2) All prices quoted to the customer are based on the full quantities specified by the customer and the company reserves the right to revise prices in the event of any quantities being reduced for whatever cause.

3) Terms of payment are strictly net, if not otherwise agreed separately in writing or marked on the front of the invoice

4) If the price of goods is not paid in full to the company within that period, then (without prejudice to any of the company's other rights and remedies in respect of such breach).

1) The company shall be entitled to recover the price of the goods from the customer by action even though property of the goods has not yet passed to the customer in accordance with the provisions of paragraph 9 below;

2) All other sums owing or incurred by the customer to the company but not already due for payment shall thereupon become due and immediately payable in full;

3) The customer shall pay interest on all sums due unpaid at the rate of 3% above Lloyds TSB base rate from time of purchase until payment is received by the company.

5. Warranty

For a Period of one year from delivery or as stated otherwise, the Company will replace components thereof found to be defective in the reasonable opinion of the Company through faulty workmanship of materials. All labour cost involved in effecting such replacements or repairs shall be borne by the Purchaser. (Optional labour warranties are usually available at the point of purchase). The Purchaser shall give the Company immediate written notice of any claim that the goods are not of stated quality in order to enable the Company to investigate the complaint before the goods are returned to the Company. Any warranties or conditions, statutory or otherwise, as to quality or fitness for any purpose except where specifically stated are excluded and except as provided for in these conditions, the Company shall accept no claim for consequential loss, damage, injury or other liability. Defects in quality or dimension in any delivery shall not be a ground for cancellation of the remainder of the contract by the Purchaser.

Where a parts and labour warranty is applicable it covers the attention and replacement of parts due to mechanical breakdown. Incorrect operation, negligence, cleaning, programming, adjustments, and issues affected by a third party are not covered. In such cases a charge will be made. Where a parts only warranty is applicable, a charge will be made for the labour content. 'Dead on Arrival' cases should be advised within 24 hours of delivery. Under no circumstances are we liable for consequential loss. Each request for service will be assessed at the point of the request whether to send out a service contractor or whether to replace the unit. In the case of replacement, a service exchange or B grade product subject to the unit's age may replace it. We will attempt to attend or resolve service requests within seven days. Some items within are sold with manufacturer's warranty and are subject to the terms and conditions of the manufacturer. Where items carry a back to base warranty, postage for warranty returns is payable by the customer.

6. Specifications

All descriptive specifications, literature, drawings, etc, submitted with the Company's quotations are approximate only, as is the descriptive literature contained in any catalogue of the Company, price list and other advertising matter.

7. Copyright

All drawings and specifications prepared by the Company shall remain the property of the Company and any drawings arising shall belong to the Company.

8. Delivery

Any time for delivery quoted by the Company will run from receipt by the Company of a written order from the Purchaser, together with receipt of all relevant information. The Company will endeavour to dispatch goods on any date quoted but will accept no liability for failure to do so. Delivery will be made anywhere in the U.K. as specified in the contract. Where a period is agreed for delivery and such period is not extended by agreement between the parties or under the provisions of conditions 11 hereof, the Purchaser shall take delivery within that period. Failure to do so shall render the Purchaser liable for any costs incurred by the Company as a result of such failure. It is the customer's responsibility to ensure that goods can be delivered successfully; i.e. door access, lifting. All damages and shortages must be signed as damaged or short, and reported at the point of delivery, as claims are invalid after 24 hours. Deliveries signed for as received in good condition or unchecked will be the customer's responsibility. Once they have been signed for in this manner, any claims for damage or shortages will be rejected. (We will attempt to resolve any damages issues, but after 24 hours there will be no possibility of pursuing a warranty claim). Our returns policy is that unused items can be returned in the original packaging subject to a 25% restocking charge and collection costs. All products are sold on a supply only basis. Installation, commissioning and positioning may be available as an extra cost option.

9. Title

1) Notwithstanding delivery and the passing of risk, property in the goods shall remain in the company until the company receives payment in full by or on behalf of the customer of all sums (whether in respect of the goods or otherwise howsoever) due owing or incurred at the time such payment is received from the customer or by the company at which time (and not earlier) property in the goods shall pass to the customer.

2) Until property in the goods passes to the customer, the customer shall be the bailee of the goods for the company and shall store the goods securely, safely, separately from the customer's own goods or those of any other person and in a manner which makes them readily identifiable as the goods of the company. The company's consent to the customer possession of the goods and any right the customer may have to possession of the goods shall cease at whichever is the earliest of the following events:

1) If any sum (whether in respect of the goods or otherwise howsoever) is not paid to the company by or on behalf of the customer on or before the date when it is due;

2) If the customer, not being a company, applies for an interim order or proposes a voluntary arrangement with the customer's creditors under part VIII of the insolvency act 1986 or does or fails to do anything which would entitle a petition for a bankruptcy order to be presented.

3) If the customer, being a company, does or fails to do anything which would entitle any person to appoint a receiver of the whole or any part of the customer's assets or which would entitle any person to present a petition for an administration order or the winding up of the customer

4) The company may for the purpose of inspecting or recovering its goods enter upon any premises where they are stored or where the company reasonably believes them to be stored

5) While the customer is in possession of the goods with the company's consent (but not otherwise), the customer may re-sell the goods provided that such sales is in the ordinary course of the customer's business and is at the price not less than the price paid or payable by the customer to the company for the goods

10. Claims for damages in transit or shortage of delivery

No claim under the above heading will be accepted unless notice is given in writing both to the Carrier and the Company at point of delivery, followed by a detailed claim not more than ten days from receipt. If goods are accepted from a Carrier without checking and signed as received in good condition, no claim whatsoever can be accepted by the Company.

11. Claim for loss of goods

No claim under the above heading will be accepted by the Company unless notice is given in writing both to the Carrier and to the Company and a detailed claim is submitted by the Purchaser not more than fourteen days after the date of consignment.

12. Suspension of deliveries

Deliveries may be wholly or partially suspended and the time of such suspension added to the time of contract in the event of a stoppage, delay or interruption of work in the establishment of either the Company, the Purchaser or a supply manufacturer during the delivery period as a result of strikes, lockouts, trade disputes, plant breakdown, accident or any cause whatsoever beyond the control of the Company or the Purchaser respectively. During such a period of total or partial suspension of delivery the Purchaser may give to the Company written notice of his wish to purchase elsewhere at his own cost and risk, such quantities of the contract goods as may be necessary to cover his current requirements and the Company will consider whether it may give permission for this to be done. Irrespective of whether the Purchaser makes any such arrangements as aforesaid or not, the Company shall not be under any liability arising out of the Company's failure to deliver.

WEEE

Our listed prices are based on you, the dealer, opting out of WEEE. If you wish to opt in to WEEE additional charges apply. Where Project is considered to be the distributor, a charge will be levied at the amount dictated by the producer.

If an end user requests for an end of life product to be collected, the end user should contact the appropriate producer or the producer's scheme agent. Where we are considered to be the producer, the end user should contact B2B on 01691 676124 or action@b2bcompliance.org.uk.

Through B2B, Project will be responsible for the recycling of any product you have purchased from Project before April 2007 as long as you are replacing with a new and similar product you are purchasing from Project, or any product that has come to the end of its useful life where Project is considered to be the producer and has been purchased from Project after July 2007 and it carries the wheelie bin logo. NB collections will be conducted at a separate from the delivery time.

Terms

Technical Information & Specification

Every effort has been made by ourselves and the manufacturers to verify technical data and display up to date images and descriptions. However, the manufacturers and ourselves reserve the right to change specifications, models and designs without prior notification. Therefore we cannot be held responsible for any such changes, errors and omissions.

Delivery, Damages and Shortages

Delivery is to kerbside only and does not include positioning and unpacking.

Delivery is to mainland UK only. Delivery to islands, highlands and remote areas are subject to a delivery surcharge.

Damages and shortages must be reported within 24 hours of delivery, failure to report any shortage or damage within this time frame will result in any claim being rejected.

Returns

For a period of 7 days from date of delivery Project Distribution Ltd will accept returns of merchandise and consider refunds or replacements according to the following conditions

Items are unused, unopened and in their original packing, it is the customers responsibility to return all items at their own expense.

Items must be returned with a valid RMA number clearly attached to the packaging.

A refund will be processed less a 25% restocking charge on returned items.

Returns will not be accepted on special order or bespoke items.

Warranty

Warranty applies to mechanical breakdowns only. Door seals, glass, cosmetic trims, lights, bulbs and consumable items are exempt. Warranty does not cover installation, commissioning, or adjustments, all equipment must be installed and commissioned by a qualified engineer in accordance with all local bylaws.

Where an extended parts and labour warranty is offered (over and above 12 months) the equipment must be maintained and serviced in accordance with the manufacturers instructions, failure to maintain the equipment in accordance with the manufacturers instructions will render the warranty void.

Warranty only applies to the original purchaser/user to whom delivered and is not transferable.

Our warranty will be null and void if

Service work is undertaken by an unqualified or unauthorised person

Our authorised service representatives are denied the right to inspect equipment

Equipment is not paid for within the terms and conditions of supply

All prices are subject to VAT at current rate. E&OE



DELIVERY OPTION SURCHARGES*		
CODE	DESCRIPTION	PRICE
-	Standard Delivery	F.O.C.
UNPACK	2 Man Delivery - Position and Unpack (Delivery to ground floor, clear access, per unit)	£95
DISPOSAL1*	Uplift and Disposal of cabinet up to 900mm wide	£100
DISPOSAL2*	Uplift and Disposal of cabinet over 900mm wide	£150
DELBON*	Overnight Delivery	£30
DELBONAM*	AM Delivery (in addition to other charges)	£20
DELBONPM*	PM Delivery (in addition to other charges)	£20
DELBON10AM*	Pre 10AM Delivery (in addition to other charges)	£25
DELBSAT	Saturday AM Delivery	£75

* Subject to postcode availability, additional charges will apply to offshore locations and some Scottish postcodes.

Surcharged postcode list

AB, BT, DD, FK8+, G63, G83-G84, IM, IV, HS, KA27+, KW, PA20+, PH, PO30+, ZE

Delivery options are available on items stocked by ourselves and do not apply to units shipped directly from the manufacturer.

Project Distribution Ltd
Unit 1 Sun Street
Stoke on Trent
Staffordshire
ST1 4JW

Tel: 01782 280289
www.prodis.co.uk
sales@prodis.co.uk

Prodis

Project Distribution Ltd
Unit 1 Sun Street
Stoke on Trent
Staffordshire
ST1 4JW

Tel: 01782 280289
Fax: 01782 215955

www.prodis.co.uk
sales@prodis.co.uk

